

HYDAC INTERNATIONAL

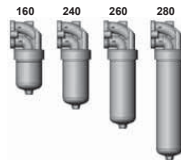

Inline Filter LPF...D A Flange-Mounted up to 280 l/min, up to 25 bar



1. TECHNICAL SPECIFICATIONS

1.1 FILTER HOUSING

Construction

The filter housings are designed in accordance with international regulations. They consist of a filter head and a screw-in filter bowl.

Standard equipment:

- bypass valve
- connection for a clogging indicator

1.2 FILTER ELEMENTS

HYDAC filter elements are validated and their quality is constantly monitored according to the following standards:

- ISO 2941
- ISO 2942
- ISO 2943
- ISO 3724
- ISO 3968
- ISO 11170
- ISO 16889

Contamination retention capacities in g

LPF...D A	Betamicron (BN4HC)			
	3 µm	5 µm	10 µm	20 µm
160	19.8	22.2	23.5	24.3
240	32.3	36.3	38.4	39.6
260	16.4	52.0	55.0	56.9
280	70.6	79.3	83.9	86.6

Filter elements are available with the following pressure stability values:
Betamicron® (BN4HC): 20 bar
Wire mesh (W/HC): 20 bar

1.3 FILTER SPECIFICATIONS

Nominal pressure	25 bar
Fatigue strength	At nominal pressure 10 ⁶ cycles from 0 to nominal pressure
Temperature range	-30 °C to +100 °C
Material of filter head	Aluminium
Material of filter bowl	Aluminium
Type of clogging indicator	VM (differential pressure measurement up to 210 bar operating pressure)
Pressure setting of the clogging indicator	5 bar (others on request)
Bypass cracking pressure	6 bar (others on request)

1.4 SEALS

NBR (= Perbunan)

1.5 INSTALLATION

As inline filter

1.6 SPECIAL MODELS AND ACCESSORIES

- Without bypass valve
- Without port (no clogging indicator)
- With bowl locking clip (only possible for size 160)

1.7 SPARE PARTS

See Original Spare Parts List

1.8 CERTIFICATES AND APPROVALS

On request

1.9 COMPATIBILITY WITH HYDRAULIC FLUIDS ISO 2943

- Hydraulic oils H to HLPD DIN 51524
- Lubrication oils DIN 51517, API, ACEA, DIN 51515, ISO 6743
- Compressor oils DIN 51506
- Biodegradable operating fluids VDMA 24568 HETG, HEES, HEPG
- Fire-resistant fluids HFA, HFB, HFC and HFD
- Operating fluids with high water content (>50% water content) on request

Symbol for hydraulic systems

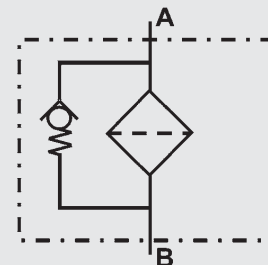

2. MODEL CODE (also order example)

LPF BN/HC 160 D A 10 D 1 X /-L24

2.1 COMPLETE FILTER

Filter type _____
LPF

Filter material _____
BN/HC Betamicon® (BN4HC)
W/HC Wire mesh

Size of filter or element _____
LPF...DA 160, 240, 260, 280

Operating pressure _____
D = 25 bar

Type and size of connection _____
A 2 mounting holes

Filtration rating in µm _____
BN4HC : 3, 5, 10, 20
W/HC : 25, 50, 100, 200

Type of clogging indicator _____
W without port (no clogging indicator)
Y plastic blanking plug in indicator port
A steel blanking plug in indicator port
B visual
C electrical
D visual and electrical } for other clogging indicators,
see brochure no. 7.050../..

Type code _____
1

Modification number _____
X the latest version is always supplied

Supplementary details _____
B. special cracking pressure of bypass (e.g. B6 = 6 bar)
GS bowl locking clip (only possible on LPF 160 D A)
KB without bypass valve
L... light with appropriate voltage (24, 48, 110, 220 Volt)
LED 2 light-emitting diodes 24 Volt
V FPM seals
W suitable for HFA and HFC emulsions

] only for clogging indicators
type "D"

2.2 REPLACEMENT ELEMENT

0160 D 010 BN4HC /-V

Size _____
0160, 0240, 0260, 0280

Type _____
D

Filtration rating in µm _____
BN4HC : 003, 005, 010, 020
W/HC : 025, 050, 100, 200

Filter material _____
BN4HC, W/HC

Supplementary details _____
V (for descriptions, see point 2.1)

2.3 REPLACEMENT CLOGGING INDICATOR

VM 5 D X /-L24

Type of indicator _____
VM Differential pressure indicator up to 210 bar operating pressure

Pressure setting _____
5 standard 5 bar, others on request

Type of clogging indicator _____
D (see point 2.1)

Modification number _____
X the latest version is always supplied

Supplementary details _____
L..., LED, V, W (for descriptions, see point 2.1)

E 7.574.1/03.12

3. FILTER CALCULATION / SIZING

The total pressure drop of a filter at a certain flow rate Q is the sum of the housing Δp and the element Δp and is calculated as follows:

$$\Delta p_{\text{total}} = \Delta p_{\text{housing}} + \Delta p_{\text{element}}$$

$$\Delta p_{\text{housing}} = (\text{see Point 3.1})$$

$$\Delta p_{\text{element}} = Q \cdot \frac{SK^*}{1000} \cdot \frac{\text{viscosity}}{30}$$

(*see Point 3.2)

For ease of calculation, our Filter Sizing Program is available on request free of charge.

NEW: Sizing online at www.hydac.com

3.1 Δp -Q HOUSING CURVES BASED ON ISO 3968

The housing curves apply to mineral oil with a density of 0.86 kg/dm³ and a kinematic viscosity of 30 mm²/s. In this case, the differential pressure changes proportionally to the density.

LPF 160, 240, 260, 280

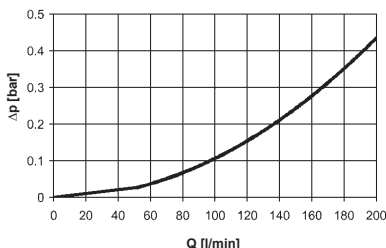

3.2 GRADIENT COEFFICIENTS (SK) FOR FILTER ELEMENTS

The gradient coefficients in mbar/(l/min) apply to mineral oils with a kinematic viscosity of 30 mm²/s. The pressure drop changes proportionally to the change in viscosity.

LPF...	BN4HC				W/HC
	3 μm	5 μm	10 μm	20 μm	
160	13.1	8.8	4.6	3.5	0.284
240	8.2	6.1	3.6	2.3	0.189
260	5.9	4.4	2.6	1.6	0.131
280	4.0	3.1	1.7	1.3	0.089

BN4HC: LPF 160

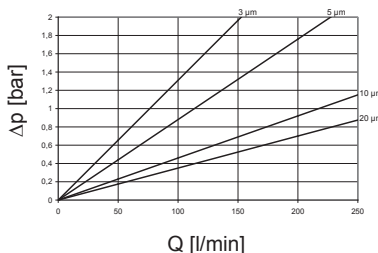

BN4HC: LPF 260

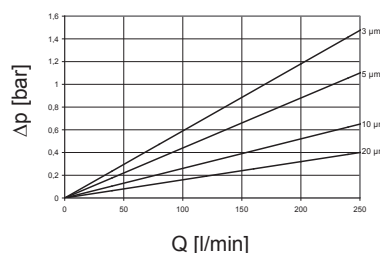

BN4HC: LPF 240

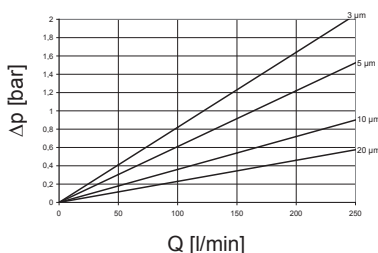

BN4HC: LPF 280

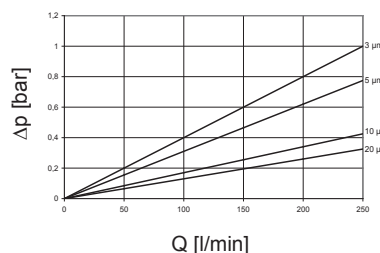

4. DIMENSIONS

LPF 160 – 280 D A

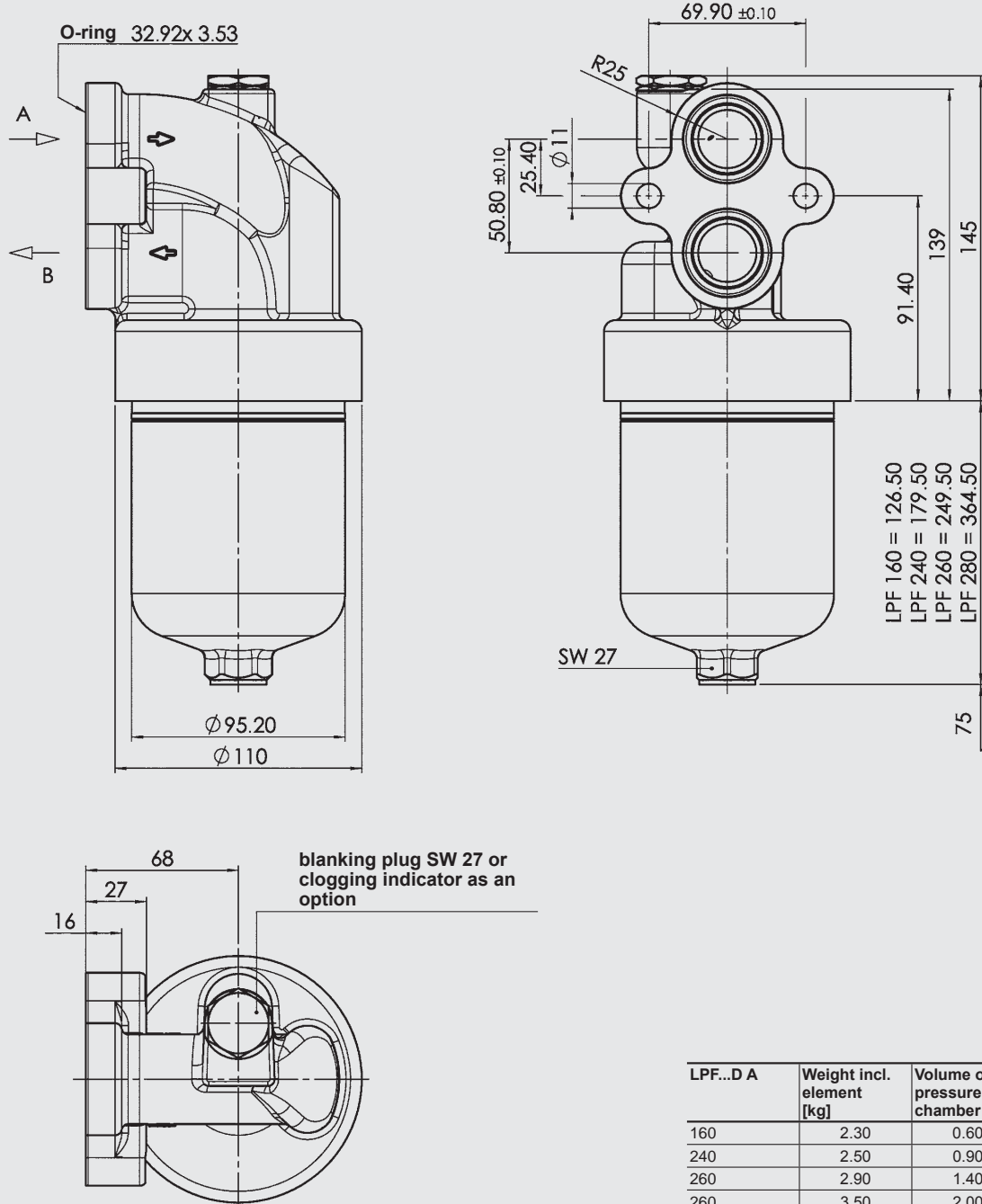

LPF...D A	Weight incl. element [kg]	Volume of pressure chamber [l]
160	2.30	0.60
240	2.50	0.90
260	2.90	1.40
260	3.50	2.00

NOTE

The information in this brochure relates to the operating conditions and applications described.
For applications or operating conditions not described, please contact the relevant technical department.
Subject to technical modifications.

E 7.574.1/03.12