

Electric Drives
and Controls

Hydraulics

Linear Motion and
Assembly Technologies

Pneumatics

Service

Rexroth
Bosch Group

Electronic contact thermometer

Type ABZMT

RE 50224-B/03.12

Replaces: -
English

Operating instructions



The data specified above only serve to describe the product. No statements concerning a certain condition or suitability for a certain application can be derived from our information. The information given does not release the user from the obligation of own judgment and verification. It must be remembered that our products are subject to a natural process of wear and aging.

© This document, as well as the data, specifications and other information set forth in it, are the exclusive property of Bosch Rexroth AG. It may not be reproduced or given to third parties without its consent.

The cover page shows an example configuration. The product supplied may therefore differ from the photo shown.

The original operating instructions were prepared in German.

Content

1	Introduction	4
1.1	Configuration.....	4
1.2	Field of application.....	4
2	Important notes	5
3	Assembly and connection	7
4	Operation	8
4.1	Switch-on	8
4.2	LED status displays	8
4.3	General key functions	9
4.4	Active key lock	10
4.5	Menu overview.....	10
4.6	Changing the basic settings.....	11
4.7	Switching outputs.....	15
4.8	Analog outputs	21
4.9	Diagnosis possibilities.....	23
5	Maintenance	26
5.1	Inspection and maintenance.....	26
5.2	Service and repair.....	26
5.3	Troubleshooting	26
6	Disposal	26
7	Technical data	27
7.1	Dimensions:	28
7.2	Pin assignment	30
7.3	Current settings	31
8	Appendix: Overview menu sequence	31

Introduction

1 Introduction

Read the operating instructions carefully before using the device. Particularly observe the notes under point 2. Otherwise, injuries or damage to property may result. Bosch Rexroth AG will not accept any liability for unauthorized changes in the device or for improper use.

1.1 Configuration

The electronic contact thermometers serve the monitoring of the temperature in fluid systems. Up to four switching outputs or one switching output in combination with an analog output are available. The display and control unit may either be mounted on the tank together with the switching tube or as remote display on a 35 mm top hat rail. In case of direct assembly, the display can be swiveled by 270°.

The switching characteristics of the outputs can be selected as window, hysteresis or as frequency output. Programming is effected via a menu that is based on the VDMA standard sheet 24574 et sq. A logbook function for storing the minimum and maximum temperature values as well as 6 events is available. Your current version is indicated on the name plate.

1.2 Field of application

WARNING!



Electronic contact thermometers are no safety components.

Use in explosive areas or in case of danger due to malfunction may impair safety and health.

- ▶ Don't use the electronic contact thermometers if in case of failure or in case of malfunction, the safety and health of persons might be impaired.
 - ▶ Don't use the electronic contact thermometers in explosive areas.
-

2 Important notes



Please check before installing the device whether the specified technical data corresponds to the application parameters. Also check whether all parts belonging to the scope of delivery are available.

Use of the devices is only admissible if:

- The product is used under the conditions described in the operating instructions, the use according to name plate and for applications for which it is intended. In case of unauthorized changes in the device, liability by Bosch Rexroth AG is excluded.
- The limits specified in the data sheet and the instructions are complied with.
- Monitoring equipment / protective equipment has been connected correctly.
- The service and repair works not described in these instructions are carried out by Bosch Rexroth AG.
- Original spare parts are used.

These operating instructions are part of the operating equipment. The manufacturer reserves the right to change the performance, specification or the design data without advance notice. Keep the instructions for later use.

In these instructions, the following warning signs and signal words are used:

Warning sign	Warning
	Warning of the inhalation of noxious gases
	Warning of corrosive fluids
	Warning of explosive areas

Signal word	Application
NOTE!	Signal word for important information on the product to which particular attention is to be drawn.
CAUTION!	Signal word for marking a hazard with little risk, which can lead to damage to property or minor to medium bodily injuries unless it is avoided.
WARNING!	Signal word for marking a hazard with medium risk, which will possibly lead to death or serious bodily injuries unless it is avoided.
DANGER!	Signal word for marking a hazard with high risk, which will directly lead to death or serious bodily injuries unless it is avoided.

The device may only be installed by specialists who are familiar with the safety requirements and the risks.

You must imperatively observe the safety regulations relevant to the place of installation as well as the generally valid rules of current technology. Prevent failures and thus prevent personal injuries and damage to property.

Important notes

The person responsible for the system must ensure that:

- Safety instructions and operating instructions are available and complied with;
- Accident prevention regulations of the Accident Prevention & Insurance Association are complied with; in Germany: BGV A1: Prevention principles and BGV A3: Electrical systems and work equipment;
- The admissible data and operating conditions are complied with;
- Protective devices are used and prescribed maintenance works are carried out;
- In the disposal, the legal regulations are complied with.

Maintenance, repair

Repairs at the operating equipment may only be carried out by personnel authorized by Bosch Rexroth.

- Only carry out modification, maintenance or assembly works described in these operating instructions.
- Only use original spare parts.
- When carrying out maintenance works of any kind, the relevant safety and operating provisions have to be observed.

DANGER!



Danger of poisoning!

Poisonous, corrosive gases or fluids may cause serious injuries.

- ▶ Protect yourself from poisonous, corrosive gases / fluids during all works.
- ▶ Always wear inhalation protection, face protection and gloves.

3 Assembly and connection

Assembly and connection may only be performed by correspondingly trained specialists. The applicable safety regulations of the place of installation are to be complied with!

DANGER!



Danger of poisoning!

Poisonous, corrosive gases or fluids may cause serious injuries.

- ▶ Protect yourself from poisonous, corrosive gases / fluids during all works.
- ▶ Always wear inhalation protection, face protection and gloves.

For direct tank attachment, the switching tube is screwed into the intended bore at the tank.

In case of installation with remote display, the display and control unit is mounted on a 35 mm top hat rail. The sensor is connected with a cable (max. length 10 m). The connector for the sensor is located on the bottom side of the display and control unit. Voltage supply and signal output are effected via the plug-in connectors on the top side.

The device is supplied with a nominal voltage of 24 V DC. For the pin assignment, please refer to the drawing in the annex.

The switching outputs are designed as PNP transistor (see figure).

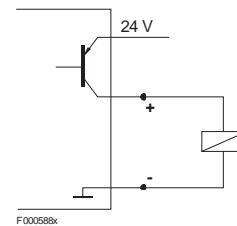

In case of measurements of the switching output with high-impedance measuring instrument inputs or in case of use as frequency output, a 10 k Ω resistance has to be connected between output and ground (GND) in order to prevent incorrect measurements.

4 Operation

4.1 Switch-on

If during ongoing operation, an error message appears in the display, please observe chapter 5.3 "Troubleshooting".

After the device has been connected to the supply voltage, the software version will in the beginning be shown shortly, e.g.  (b2.03).

Directly afterwards, the display changes to the measured value display.

In the following, the function of the display and control unit is described.

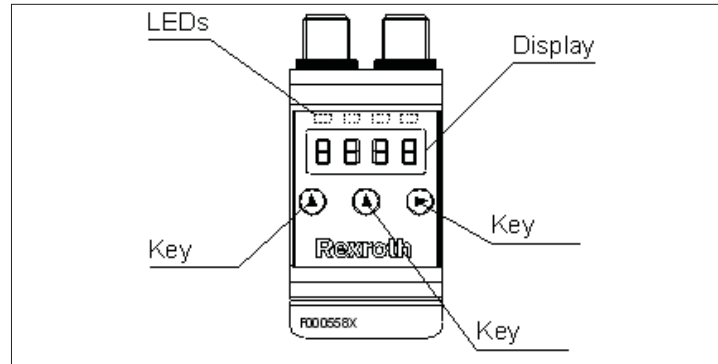

4.2 LED status displays

Light-emitting diodes above the measured value display signal the status of the temperature switching outputs. The LEDs are fixedly assigned to the switching outputs. The following table shows the factory settings.

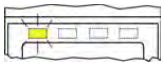
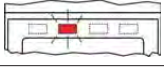
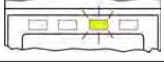
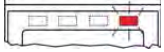

	LED 1 - yellow Assigned: Switching output 1
	LED 2 - red Assigned: Switching output 2 (if available)
	LED 3 - yellow Assigned: Switching output 3 (if available)
	LED 4 - red Assigned: Switching output 4 (if available)

The LEDs' switching behavior (illuminated in case of closed or open switching contact) can be changed; in this connection see chapter 4.7.7.

4.3 General key functions

Operation is effected using the keys below the display.

A detailed explanation of the menu control is contained in the following chapters.

Key	Mode	Function
▶	Measured value display:	Change of the displayed units; example: 
	In the menu:	Change to a subordinate menu
	At the end of the menu:	Change to the superior menu:  (Exit) signals the end of the menu
	After entry / selection:	Confirming and storing an entered numerical value or a function selection.
▲	Measured value display:	Display of the configuration
	In the menu:	Going to the next menu item, numerical value or function selection. If the key is kept pressed, this is done continuously.
▼	Measured value display:	Change to the main menu
	In the menu:	Going to the previous menu item, numerical value or function selection. If the key is kept pressed, this is done continuously.
▼+▶*	In the menu:	Exiting the main / sub- / optional menu and jump back to the measured value display
▲+▶*	In the menu:	Changing to the next higher menu level
No action for 60 s*	In the menu:	Exiting the main / sub- / optional menu

* If the optional or setup menu is exited, the changed values will not be stored.

For selecting a menu item and setting the values, proceed as follows:

- ▶ Open the main menu by means of the ▶ key.
- ▶ Select the submenu with the ▼ and ▲ keys and open the submenu using the ▶ key.
- ▶ Select the next submenu with the ▼ and ▲ keys, if applicable, and open it using the ▶ key.
- ▶ Select the desired menu item using the ▼ and ▲ keys and open the value list using the ▶ key.
- ▶ Set the value using the ▼ and ▲ keys and confirm it using the ▶ key.

The changed settings are stored and the device returns to the submenu.

- ▶ Exit the submenu by selecting the EXIT menu item and confirming it using the ▶ key.

The device returns to the superior menu or the measured value display.

Operation

4.4 Active key lock

When the key lock is activated, the following display will appear instead of the main menu when calling the menu using the ▼ key:



The active number is marked by a point.

- ▶ Enter the code using the ▲ and ▼ keys and confirm it using the ► key.

The active number is moved one digit to the right.

After entry of the 3rd number, the main menu opens.

If a wrong numerical code is entered, the device jumps back to the measured value display. If you have forgotten the password, you can access the menu at any time by means of the master code 287.

You can cancel the key lock by resetting the code with the entry 000 in the *Loc* menu item in the "**Basic ext. functions**" *bEF* submenu.

4.5 Menu overview

The menu structure is based on the VDMA standard sheet 24574 et sq. The menu is structured hierarchically. The topmost menu level contains the main menu entries, e.g. *tERP*, *bEF*, *d, R*, *E*. Each main menu comprises more submenu items.

The menu items may vary depending on the device configuration. Not all menu items described in the following may be available in your device.

- ▶ You can call the configuration by pressing the ▲ key in the display mode.

A 4-digit code will be displayed, e.g.

	<p>Whereas the 4 digits tsav have the following meaning:</p> <table border="0"> <tr> <td>t: Type</td> <td>t = Temperature measurement</td> </tr> <tr> <td>s: Number of switching outputs</td> <td>1, 2 or 4</td> </tr> <tr> <td>a: Number of analog outputs</td> <td>0 or 1</td> </tr> <tr> <td>v: Assembly type of the devices</td> <td>i = Standard assembly (tank installation) F = Remote display</td> </tr> </table>	t: Type	t = Temperature measurement	s: Number of switching outputs	1, 2 or 4	a: Number of analog outputs	0 or 1	v: Assembly type of the devices	i = Standard assembly (tank installation) F = Remote display
t: Type	t = Temperature measurement								
s: Number of switching outputs	1, 2 or 4								
a: Number of analog outputs	0 or 1								
v: Assembly type of the devices	i = Standard assembly (tank installation) F = Remote display								

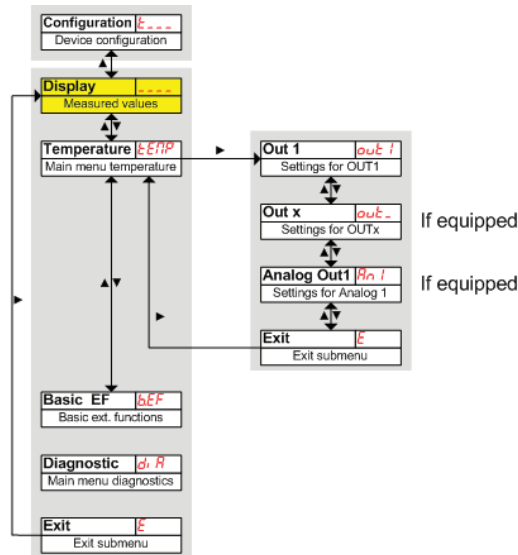

The individual menu items will not appear if the option is not available. Example: With a = 0, the menu items for setting the analog output are not available. You can then skip the description of these points.

The structure of the menus for the switching and analog outputs is similar. Here, the settings for the switching outputs and/or the analog outputs (if available) are made.

The basic settings of the device can be changed. Generally valid settings are made in the "Basic ext. functions" (bEF) menu. These settings should be made first as they influence the displays and setting possibilities in the individual menus. Such settings include e.g. the units used.

In addition, diagnosis possibilities are available in the "Diagnostic" menu.

For the detailed presentation of the entire menu structure please refer to the end of these instructions.

4.6 Changing the basic settings

In the "Basic ext. functions" (bEF) menu, the generally valid basic settings are made. These settings influence the presentation in the measured value display as well as the setting options in the "Temperature" menu.

- ▶ In order to access the main menu, press the ▼ key.
- ▶ Select the bEF menu item using the ▼ and ▲ keys and open the menu using the ► key.

4.6.1 Determining the temperature unit

Here, the displayed unit symbol for the temperature is determined.

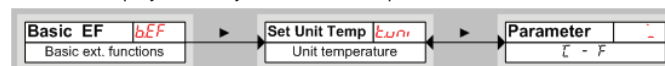

The following options are available:

	Degree Celsius	Degree Fahrenheit



If the setting is changed, all related settings like e.g. setting of the switching points are changed accordingly.

Operation

4.6.2 Determining the feed line length

In case of installation with remote display, the length of the feed line and also the cross-section must be entered for the exact temperature measurement in order to compensate for the line resistance in the calculation.

The line length should be adjusted in the following menu:



 Setting range 0 m ... 20 m	Length of the measuring cable for compensating the feed line resistance Pt100
-----------------------------------	---



As feed and return line have to be considered, twice the cable length is to be entered!

4.6.3 Determining the feed line cross-section

Enter the line cross-section of the feed line here.

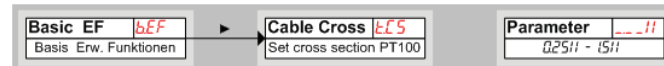

 Setting range 0.25 to 1.5	Cross-section of the measuring cable in mm ² for compensating the feed line resistance Pt100
------------------------------------	---



|| stands for mm².

4.6.4 Setting the display's update rate

Depending on the application, the display's update rate can be set. The display can also be switched off completely. The LEDs will still function.



	The following options are available:			
	Fast	Medium	Slow	Display off



Error messages will be displayed despite switched-off display.

4.6.5 Activating / deactivating the key lock

In order to prevent unauthorized changes in the device settings, a key lock can be setup.



The key lock is activated if at least one number > 0 is entered. During the entry, the active number is marked with a point.

	<ul style="list-style-type: none"> ▶ Open the value list by means of the ► key: ▶ Set the figure using the ▼ and ▲ keys (0 to 9) and confirm it using the ► key. The active number is moved one digit to the right. ▶ Finally confirm the code by means of the ► key. The device returns to the submenu.
--	--

Setting range:
000 to 999



Canceling the key lock with the entry: 000
Master code 287

4.6.6 Restoring the factory settings (reset)

By means of the "Reset" (*rES*) function, the factory settings can be restored. When doing so, all changes will be lost. As the limits are also reset, the settings for the temperature must mandatorily be checked.



	<p>The following options are available:</p>	
	<p>Condition as supplied: No, the current settings are maintained</p>	<p>Condition as supplied: Yes, the settings are reset to the default factory settings.</p>

Operation

The factory settings are as follows:

Definitions:

<i>SPx / rPx</i>	Switching point / switch-back point x
<i>dSx. / drx</i>	Switch-on delay / switch-back delay for switching output x
<i>Rx.Hi. / Rx.Lo</i>	Maximum and minimum measured value for the output
<i>RouX</i>	Signal form of the analog output
<i>ouX</i>	Switching characteristic of the switching output x
<i>tuni</i>	Temperature unit
<i>rouX</i>	Allocation of the switching output x for temperature monitoring
<i>di S</i>	Display update rate
<i>Loc</i>	Key lock
<i>Souou</i>	Logged switching output
<i>dtm</i>	Delay until recording of the minimum / maximum temperature



With customer specifications, the factory pre-setting may deviate from the values listed here.

Version with 2 switching outputs:

Switching outputs		Basic settings		Diagnosis	
<i>SP1 / rP1</i>	<i>50 / 45</i>	<i>tuni</i>	<i>C</i>	<i>Souou</i>	<i>out 1</i>
<i>dS1 / dr1 / ou1</i>	<i>0 / 0 / Hno</i>	<i>rou1</i>	<i>tENP</i>	<i>dtm</i>	<i>00</i>
<i>SP2 / rP2</i>	<i>60 / 55</i>	<i>rou2</i>	<i>tENP</i>		
<i>dS2 / dr2 / ou2</i>	<i>0 / 0 / Hno</i>	<i>di S</i>	<i>FRSt</i>		
		<i>Loc</i>	<i>000</i>		

Version with 4 switching outputs:

Switching outputs		Basic settings		Diagnosis	
<i>SP1 / rP1</i>	<i>50 / 45</i>	<i>tuni</i>	<i>C</i>	<i>Souou</i>	<i>out 1</i>
<i>dS1 / dr1 / ou1</i>	<i>0 / 0 / Hno</i>	<i>rou1</i>	<i>tENP</i>	<i>dtm</i>	<i>00</i>
<i>SP2 / rP2</i>	<i>60 / 55</i>	<i>rou2</i>	<i>tENP</i>		
<i>dS2 / dr2 / ou2</i>	<i>0 / 0 / Hno</i>	<i>rou3</i>	<i>tENP</i>		
<i>SP3 / rP3</i>	<i>70 / 65</i>	<i>rou4</i>	<i>tENP</i>		
<i>dS3 / dr3 / ou3</i>	<i>0 / 0 / Hno</i>	<i>di S</i>	<i>FRSt</i>		
<i>SP4 / rP4</i>	<i>80 / 75</i>	<i>Loc</i>	<i>000</i>		
<i>dS4 / dr4 / ou4</i>	<i>0 / 0 / Hno</i>				

Version with 1 switching output and 1 analog output:

Switching outputs		Basic settings		Diagnosis	
<i>SP1 / rP1</i>	<i>50 / 45</i>	<i>tuni</i>	<i>C</i>	<i>Souou</i>	<i>out 1</i>
<i>dS1 / dr1 / ou1</i>	<i>0 / 0 / Hno</i>	<i>rou1</i>	<i>tENP</i>	<i>dtm</i>	<i>00</i>
Analog output		<i>di S</i>	<i>FRSt</i>		
<i>Rx.Hi. / Rx.Lo / Rou1</i>	<i>0 / 100 / . 1</i>	<i>Loc</i>	<i>000</i>		

4.7 Switching outputs

All switching outputs are set in the same way. The number of the switching output is therefore shown with x. Call up the switching output to be set via the menu of the corresponding measurement.







In the "Extend functions" submenu, more settings for each individual switching output can be made which influence e.g. the switching behavior of the output. Here, the output can also be tested.

4.7.1 Switching output x: Definition of the switching characteristic

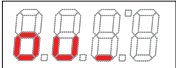
The switching characteristic for the output is determined in the following menu:

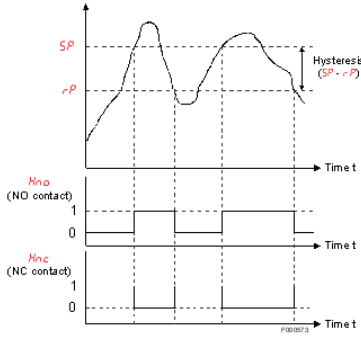

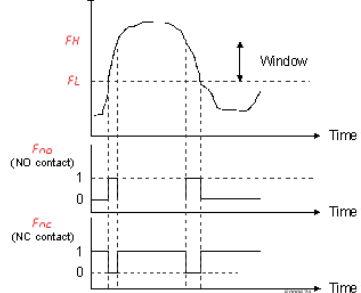
 <p>Hysteresis function</p>  <p>Hysteresis function as normally open contact</p>  <p>Hysteresis function as normally closed contact</p>	<p>The following options are available:</p> <p>Normally open or closed contact function in which the output signal will be set if the set switching points are exceeded. If the set switch-back point is undershot, the output signal will be deleted.</p> <p>Here, normally open contact means that the PNP switching output is closed above the SPx switching point and opens again if the rPx switch-back point is undershot.</p> <p>Here, normally closed contact means that the PNP switching output is open above the SPx switching point and closes again if the rPx switch-back point is undershot.</p> <p>Also refer to the explanation in the following drawing.</p> 
<p>Window function</p>  <p>Window function as normally open contact</p>  <p>Window function as normally closed contact</p>	<p>Normally open or closed contact function by means of which a signal window is determined. If the measuring window is reached, the output signal is set, if the window is left, it will be deleted again.</p> <p>Here, normally open contact means that the PNP switching output is closed if the value is within the window. Otherwise, the switching output is open.</p> <p>Here, normally closed contact means that the PNP switching output is open if the value is within the window. Otherwise, the switching output is closed.</p> 

Operation

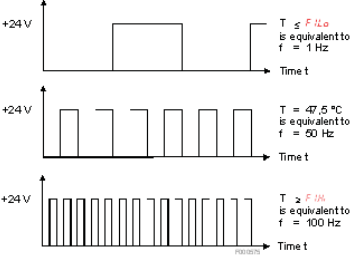
<p>Frequency output</p>  <p>Frequency output</p>	<p>If the output is defined as frequency output, a rectangular signal with a frequency between 1 Hz and 100 Hz proportionate to the measured value is output.</p>	<p>Example: $F_{1Hz} = 15^\circ\text{C}$, $F_{100} = 90^\circ\text{C}$ with temperature T and frequency f:</p> 
--	---	---



In order to increase the edge steepness of the rectangular signal, we recommend loading the switching output with a 10 kΩ resistance.



The switching function may have different designations:

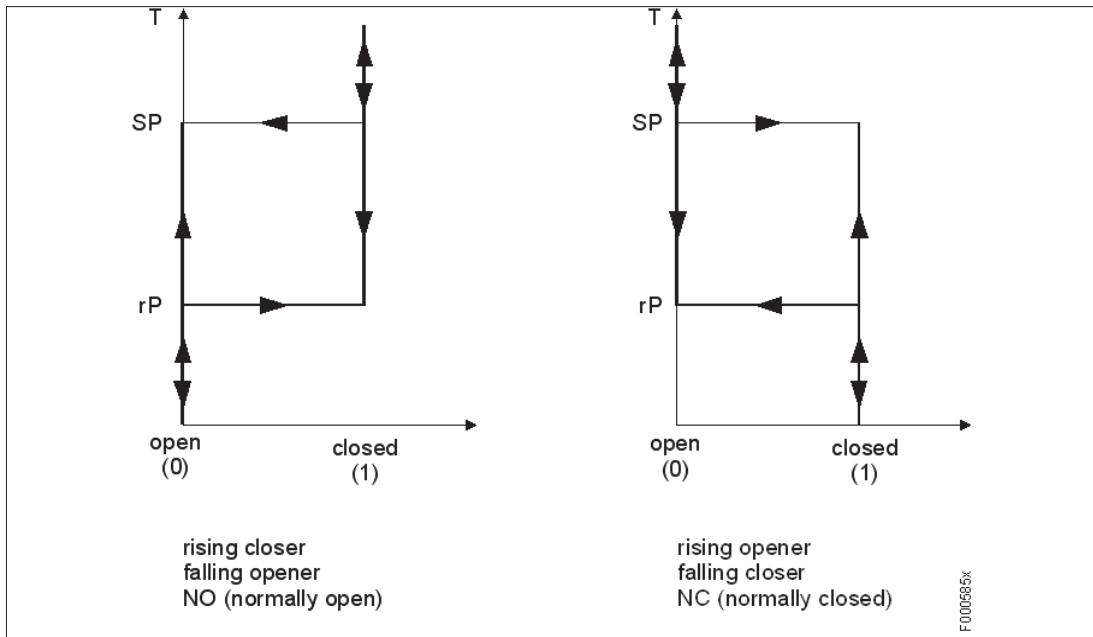

4.7.2 Switching output x: Upper switching limit (switch-on point)

The upper switching limit for the Out x switching output is set in the following submenu:



	Switching point for OUT x
Setting range 0 °C to 100 °C (32 °F to 212 °F)	



The switching point must be selected within the range limits (see "**Basic ext. functions**" menu).

If the OUT 1 switching output has been assigned the "**Window**" function,

will be displayed.

The set value corresponds to the upper window limit.

If the OUT 1 switching output has been assigned the "**Frequency output**"

function, will be displayed.

The set value corresponds to the frequency 100 Hz.

4.7.3 Switching output x: Lower switching limit (switch-back point)

The lower switching limit for the Out 1 switching output is set in the following submenu:



	Switch-back point for OUT 1
Setting range 0 °C to 100 °C (32 °F to 212 °F)	



The switch-back point must be selected within the range limits.

If the OUT 1 switching output has been assigned the "**Window**" function,

will be displayed.

The set value corresponds to the upper window limit.

If the OUT 1 switching output has been assigned the "**Frequency output**"

function, will be displayed.

The set value corresponds to the frequency 1 Hz.

Operation

4.7.4 Switching output x: Switch-on delay

In the "Extend functions" *EFx* menu, more settings for the x switching output can be made. The submenu is located on the second submenu level.

The switching and switch-back delay time prevent the alarm from responding too frequently in case of unstable conditions. The switching delay is set in the following menu:



Setting range:
0...100 seconds

Time period in seconds during which the signal must be continuously available for the switching output to respond.



If the OUT x switching output has been assigned the "Window" function, the set value corresponds to the switch-on delay detecting the valid achievement of the measuring window.

If the OUT x switching output has been assigned the "Frequency output" function, this value will have no effect.

4.7.5 Switching output x: Switch-back delay

The switch-back delay is set in the following menu:

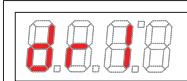

Setting range:
0...100 seconds

Delay of the switch-back signal for OUT x
Time period in seconds during which the signal must be continuously available for the switching output to respond.



If the OUT 1 switching output has been assigned the "Window" function, the set value corresponds to the switch-on delay detecting the valid leaving of the measuring window.

If the OUT 1 switching output has been assigned the "Frequency output" function, this value will have no effect.

4.7.6 Switching output x: Testing of the switching output

The test of the switching output can be started in the following menu:

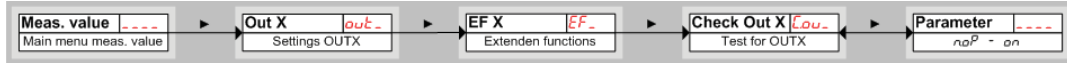

Test possibility for the switching output

Options when setting *out* to *Hno* / *Hnc* / *Fno* / *Fnc*:

 Normal operation of the switching output	 Permanently deactivating the switching output	 Permanently activating the switching output
Options when setting <i>out</i> to <i>Ffi</i> :		
 Normal operation as frequency output	 Output Frequency 1 Hz	 Output Frequency 100 Hz



After termination of the test, you should imperatively set the function to *noP* normal operation.

4.7.7 Changing the display function of the status LED

The switching status of the output is signaled by the LEDs in the display. The allocation of the LED to the switching output can be seen from the following table:

Numbering LED	Switching output x	Allocation with 1 switching output	Allocation with 2 switching outputs	Allocation with 4 switching outputs
LED 1 2 3 4 F000556x	1	LED 1 – yellow	LED 1 – yellow	LED 1 – yellow
	2		LED 2 - red	LED 2 - red
	3			LED 3 – yellow
	4			LED 4 - red

In the factory setting, the LED indicates the physical condition of the PNP switching output (switching output closed – LED illuminated).

You might want the logical function of the display to work in a different way than the physical signal on the switching output. You can therefore also reverse this display in this menu item (switching output open – LED illuminated).

Example using the temperature:







You have 2 switching outputs for the temperature, which are set as follows:

- Upper switching contact: Max. contact, rising closer. The LED is illuminated if the maximum temperature value is exceeded and the temperature is outside the desired range. So the indicated status is "error" if the LED is illuminated.
- Lower switching contact: Min. contact, rising closer. So with the factory setting, the LED is illuminated if the minimum temperature value is exceeded. So in this case, the LED would be illuminated if the status is ok.

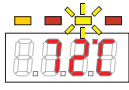
Operation

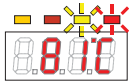

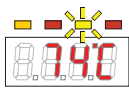
The table shows an example with the factory setting and with inverted status function for LED3. The switching points are defined as follows:

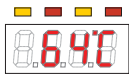
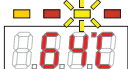
SP3 = 70 °C, rP3 = 65 °C
SP4 = 80 °C, rP4 = 75 °C

	Factory setting	Status function LED inverted	Condition	Status
A	 LED3 ON	 LED3 OFF	Temperature increases to > 70 °C PNP switching output 3 closed	OK
B	 LED4 and LED3 ON	 only LED4 ON	Temperature increases to > 80 °C PNP switching output 4 closed	Error
C	 LED3 ON	 LED3 OFF	Temperature decreases to < 75 °C PNP switching output 4 open	OK
D	 LED3 OFF	 LED3 ON	Temperature decreases to < 65 °C PNP switching output 3 open	Error

Here, you can reverse the LED status function for a contact: The LED is illuminated if the contact is open, i.e. below the minimum temperature, and the "Error" status is indicated again if the LED is illuminated. The recording of events particularly depends on the lighting up of the LED (see chapter "Diagnosis possibilities", 4.9).



	The following options are available	
	 LED = output; the LED is illuminated if the PNP switching output is closed.	 LED = -output; the LED is illuminated if the PNP switching output is open.



The recording of events particularly depends on the lighting up of the LED (see chapter "Diagnosis possibilities", 4.9).

4.8 Analog outputs

4.8.1 Analog output x: Allocation of the upper limit

Here, it is allocated at which temperature the maximum analog signal is to be output. The setting is made in the menu.



<p>Setting range 0 °C to 100 °C (32 °F to 212 °F)</p>	<ul style="list-style-type: none"> ▶ Open the value list by means of the ▶ key. ▶ Set the value using the ▼ and ▲ keys and confirm it using the ▶ key (e.g. 10 °C). <p>The device returns to the submenu.</p>
---	---



The set output range must not be selected to be less than 10 % of the measurement range. $RiHi - RiLo \geq 10\%$

If the selected range is too small, the analog value output may show steps.

4.8.2 Analog output x: Allocation of the lower limit

Here, it is allocated at which temperature the minimum analog signal is to be output. The setting is made in the menu.

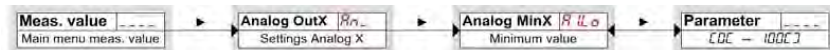

<p>Setting range: 0 °C to 100 °C (32 °F to 212 °F)</p>	<ul style="list-style-type: none"> ▶ Open the value list by means of the ▶ key. ▶ Set the value using the ▼ and ▲ keys and confirm it using the ▶ key (e.g. 80 °C). <p>The device returns to the submenu.</p>
--	---



The set output range must not be selected to be less than 10 % of the measurement range. $RiHi - RiLo \geq 10\%$





If the selected range is too small, the analog value output may show steps.

Operation

4.8.3 Analog output x: Determining the signal form

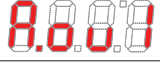
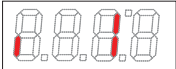
The analog output can be defined as voltage or current output with different value ranges. The setting is made in the menu.





 Setting range: 0 °C to 100 °C (32 °F to 212 °F)	The following options are available:			
	 4 mA to 20 mA	 2 V to 10 V	 0 V to 10 V	 0 V to 5 V

4.8.4 Analog output x: Testing the analog output

The analog output can be tested, as well. The largest, the medium and the smallest analog value can be output one after the other. The setting is made in the menu.

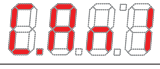
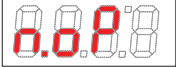
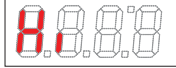

	The following options are available:	
	 Normal operation	 Output highest analog value
	 Output medium analog value (e.g. 12 mA with setting 4-20 mA)	 Output lowest analog value



After termination of the test, you should imperatively set the function to **noP** normal operation.

4.9 Diagnosis possibilities

The device is able to log events for a switching output. An event is defined as the lighting up of the LED. I.e. the recording of the switching processes depend on the setting of the LED switching function (see 4.7.7).

The settings and the analysis can be made here.



Only one switching output can be logged. The switching output to be logged is set in the *Swout* menu item.

- ▶ In order to access the main menu, press the ▼ key.
- ▶ Select the *d: R* menu item using the ▼ and ▲ keys.

	<p>From here, you can access different diagnosis values and logs regarding the filling level and temperature monitoring.</p> <ul style="list-style-type: none"> ▶ Open the menu by means of the ► key. <p>No, you can change and/or call the diagnosis settings.</p>
--	---

4.9.1 Calling the log book

Here, the last 6 events of the logged switching output can be called or deleted.



The log entries are displayed in the following way:	Example:
<ul style="list-style-type: none"> • Latest event <i>Swout 1</i> occurred before x hours (h) / days (d), • Events 2 to 5 occurred before x hours / days, • The oldest event <i>Swout 6</i> occurred before x hours / days • Delete function (---). 	<p><i>Swout 1</i> ⇔ 13h, key ▼</p> <p><i>Swout 2</i> ⇔ 24h, key ▼, ▲</p> <p><i>Swout 3</i> ⇔ 6.1h, key ▼, ▲</p> <p><i>Swout 4</i> ⇔ 82h, key ▼, ▲</p> <p><i>Swout 5</i> ⇔ non *, key ▼, ▲</p> <p><i>Swout 6</i> ⇔ non *, key ▼, ▲</p> <p>---, key ▲; ► = delete</p>

* Not yet assigned, only 4 events have occurred

	<p>The index of entry x and the time are indicated alternately, e.g.</p> <p><i>Swout 1</i> <-> 14h for the latest event 1.4 hours ago.</p> <ul style="list-style-type: none"> ▶ Confirming the display by means of the ► key. <p>Deletes the event list and returns to the submenu.</p>
--	--

Operation



If no events have been recorded, the display changes between *varX* and *nan*. The stored data will be overwritten after 6 months.

4.9.2 Maximum and minimum temperature

Here, the stored maximum and minimum temperature are displayed or deleted.



The values are displayed in the following way	Example:
• Maximum temperature value,	72 ℃, key ▼
• Reached x hours / days ago,	84h, key ▼, ▲
• Minimum temperature value,	22 ℃, key ▼, ▲
• Reached x hours / days ago,	2.1h, key ▼, ▲
• Delete function.	---, key ▲; ► = delete



Menu order:
Max. value,
time
Min. value,
time
delete (reset)

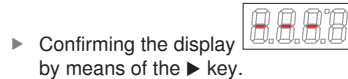

► Confirming the display by means of the ► key.

Deletes the event list and returns to the submenu.



The stored data will be overwritten after 6 months.

4.9.3 Determining the switching output to be logged

Here, the switching output to be logged is selected. Only one switching output can be logged.

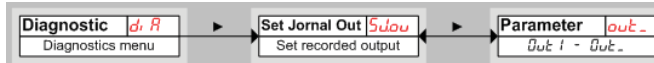

Selection:
out.1 to out.X

- Open the value list by means of the ► key.
- Select the value using the ▼ and ▲ keys and confirm it using the ► key.

The device returns to the submenu.



The values are stored from the volatile memory into the non-volatile memory approx. every three hours.

The stored data will be overwritten after 6 months.

4.9.4 Delay until storage of the min/max temperature

In order to record reliable values in case of temperature fluctuations, a delay time until storage of the minimum and maximum temperature can be set. Here, the time period in seconds is indicated during which the signal must be continuously available before the temperature will be logged.

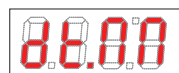
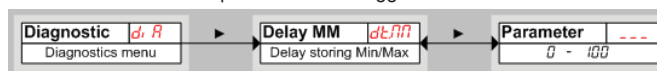

Set the desired delay.

Setting range:
0...100 seconds

5 Maintenance

5.1 Inspection and maintenance

The device is working in a maintenance-free way.

5.2 Service and repair

If an error occurs during operation, the following table provides troubleshooting information.





If you have any questions, please contact one of the Bosch Rexroth service representations. In this connection, please keep the data of the name plate ready.

If after removal of possible failures and switch-on of the mains voltage the device does not function correctly, it must be checked by the manufacturer. For this purpose, please put the device in suitable packing and return it to one of the Bosch Rexroth service representations.

For the addresses of our service representations please refer to www.boschrexroth.com/adressen.

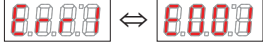
5.3 Troubleshooting

In case of an error, all outputs are de-energized. The four LEDs flash. Errors remain stored in the device until switch-off.

Problem / failure	Possible cause	Remedy
No display	No supply voltage	Check cables and replace, if necessary
Error messages in the display: Change between <i>Err</i> and <i>Exxx</i> : e.g.		
 Error 01	Ambient temperature too low	Comply with the limits
 Error 02	Ambient temperature too high	Comply with the limits
 Error 04	Pt 100 defective (short circuit)	Replace the feed line Pt100 Send in the device for repair
 Error 08	Pt 100 defective (cable break)	Replace the feed line Pt100 Send in the device for repair

6 Disposal

In the disposal, the legal regulations of the country of use are to be observed, particularly the regulations regarding the disposal of electronic components.

7 Technical data

Probe:	
Operating pressure	max. 5 bar
Operating temperature	-40 °C to +100 °C (-40 °F to 212 °F)
Material	Brass or stainless steel 1.4571

Display:	
Temperature display range	-20 °C to +120 °C (-4 °F to 248 °F)
Setting range alarm	0 °C to 100 °C (32 °F to 212 °F)
Accuracy	1 %
Resolution	0.5 °C
Protection class housing	IP65
Current consumption upon switch-on	ca. 100 mA for 100 ms
Current consumption in operation	ca. 50 mA
Supply voltage	10 V to 32 V DC (nominal voltage 24 V DC)
Ambient temperature	-20 °C to 70 °C (-4 °F to 158 °F)

Outputs temperature:	
Temperature sensor	Pt 100 class B, DIN EN 60751
Plug-in connector sensor input	M12, 4-pole, socket
Plug-in connector output	M12, 4-pole, base
Version	1, 2 or 4 PNP transistor output, programmable
Switching current	max. 0.5 A per output, max. 1 A in total
Analog output	1 analog output 4-20 mA, 2-10 V, 0-10 V or 0-5 V

Technical data

7.1 Dimensions:

All dimensions in mm

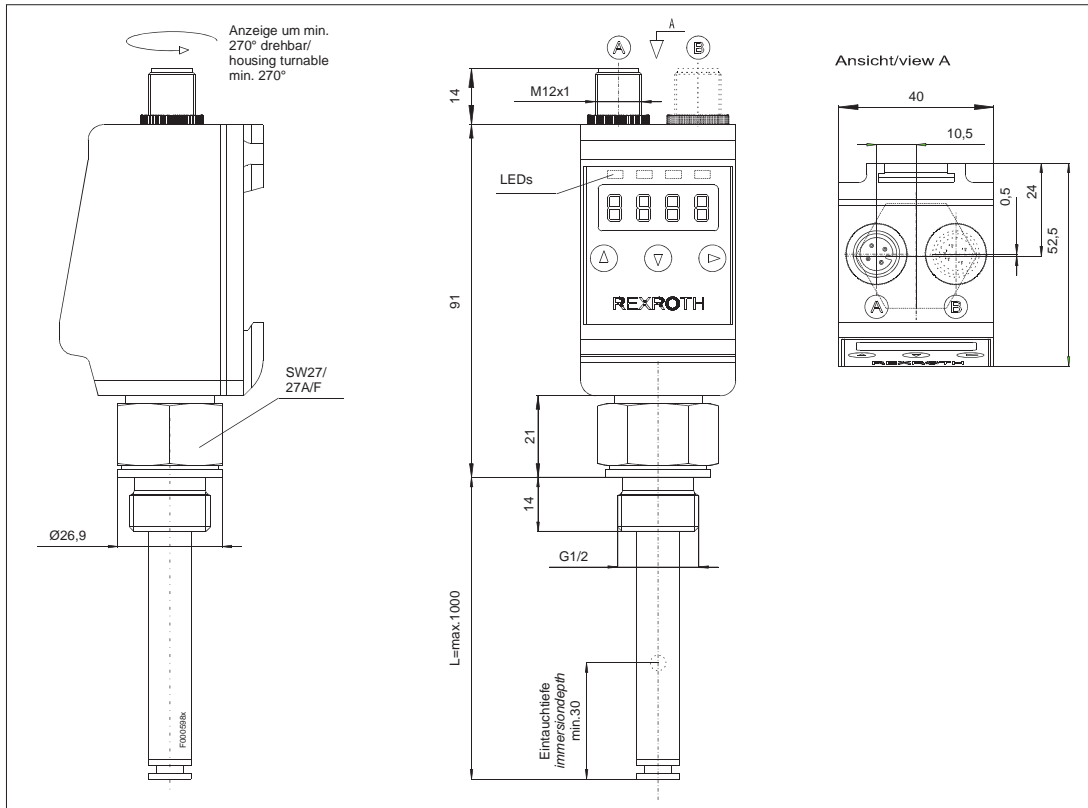

RE 50224-B/03.12 | Type ABZMT

Bosch Rexroth AG 29/36

Technical data

Remote display

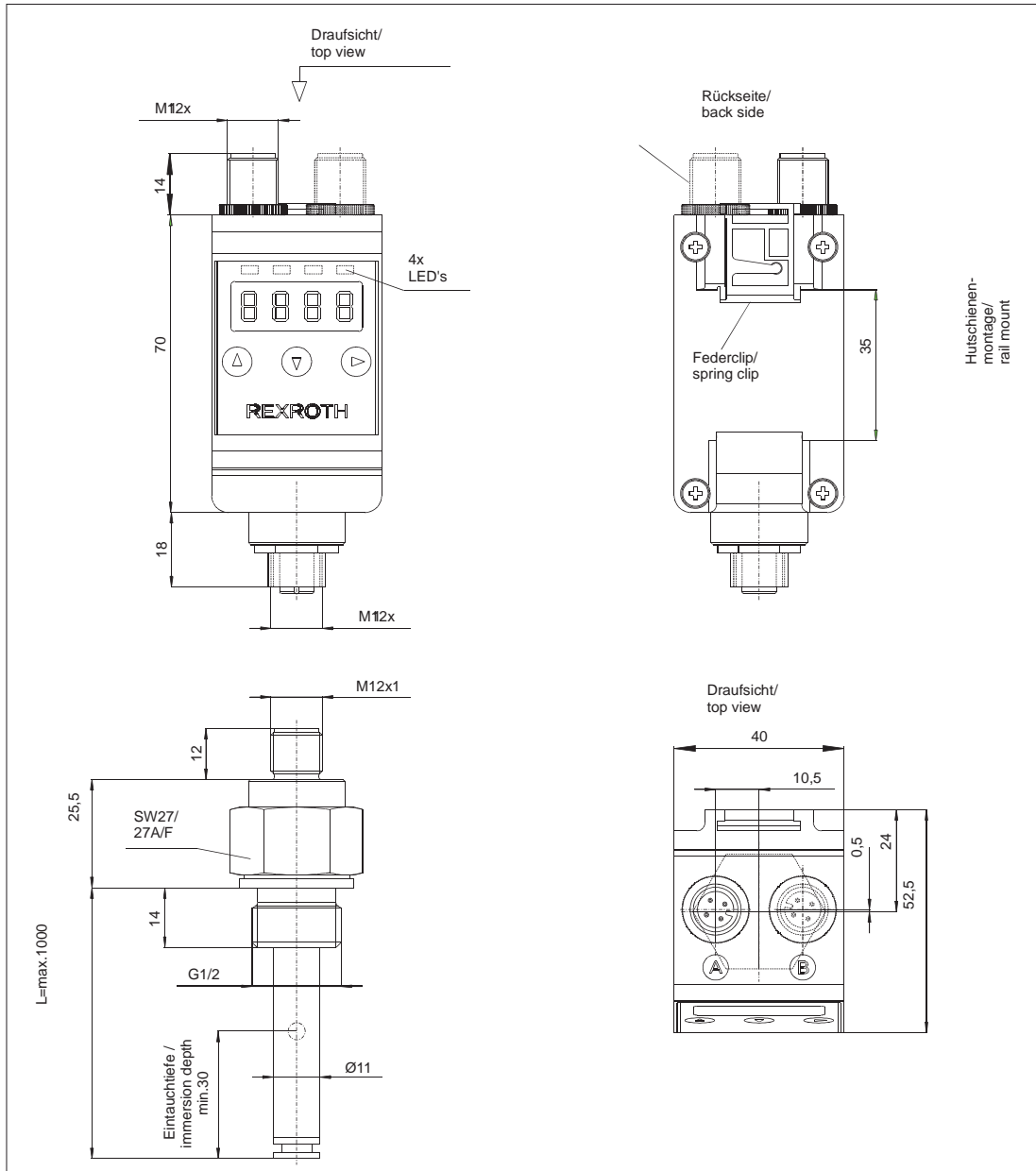

Technical data

7.2 Pin assignment

Direct assembly

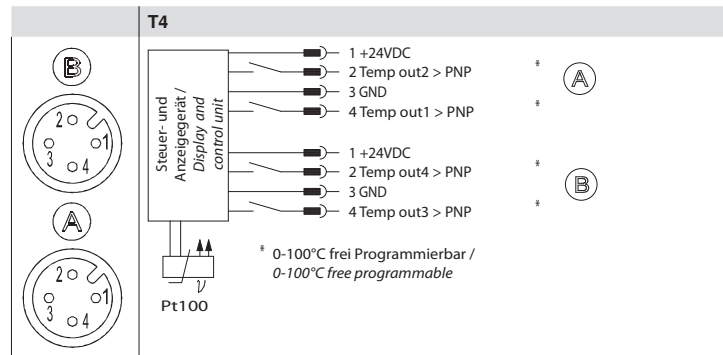
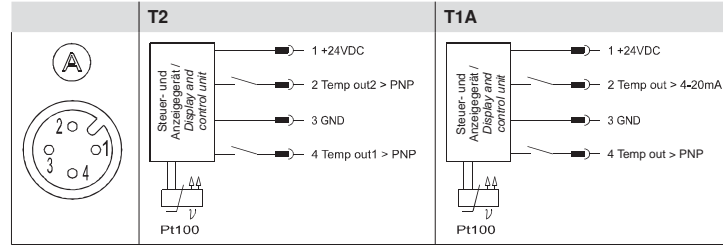

Remote display

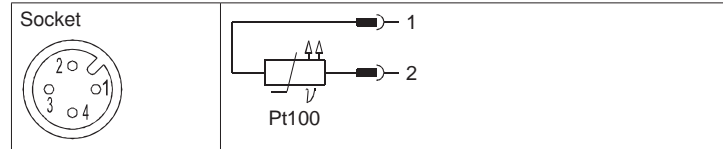

7.3 Current settings

Version with up to 4 switching outputs:

Switching outputs	Basic settings	Diagnosis
SP1 / rP1	oU1	SJou
dS1 / dr1 / ou1	tU1	tN1
SP2 / rP2	oU2	dEtN2
dS2 / dr2 / ou2	oLo	
SP3 / rP3	d, S	
dS3 / dr3 / ou3	Loc	
SP4 / rP4		
dS4 / dr4 / ou4		

Version with up to 2 switching outputs and up to 2 analog outputs:

Switching outputs	Basic settings	Diagnosis
SP1 / rP1	oU1	SJou
dS1 / dr1 / ou1	tU1	tN1
SP2 / rP2	oU2	dEtN2
	oLo	
Analog outputs		d, S
RH1 / RLo / Rou1	Loc	

Date: _____ Signature: _____

8 Appendix: Overview menu sequence

Appendix: Overview menu sequence

