



ROEMHELD
HILMA ■ STARK

Issue 4-16 E

D 8.021

Power Unit - Basic version -



General data

Design	81XX-gear pump 82XX-radial piston pump 8223-X25 two-stage hydraulic pump
Type of mounting	foot mounting
Porting	G 1/4
Direction of rotation	For radial piston pumps any, for gear pumps clockwise, for 2-stage hydraulic pumps counterclockwise (viewed from above onto drive shaft).
Mounting position	upright
Reservoir volume	V = 11 l
Usable oil volume	V _n = 6 l

Hydraulic data

Volumetric efficiency	$\eta_{vol} = 85-95\%$ with gear pumps $\eta_{vol} = 92-96\%$ with radial piston pumps
-----------------------	---

Control variants

By mounting different valve groups (examples see following pages) hydraulic controls as needed can be delivered.

Design

Design of the hydraulic as well as the electric control as per customer's requirements.

Please contact us.

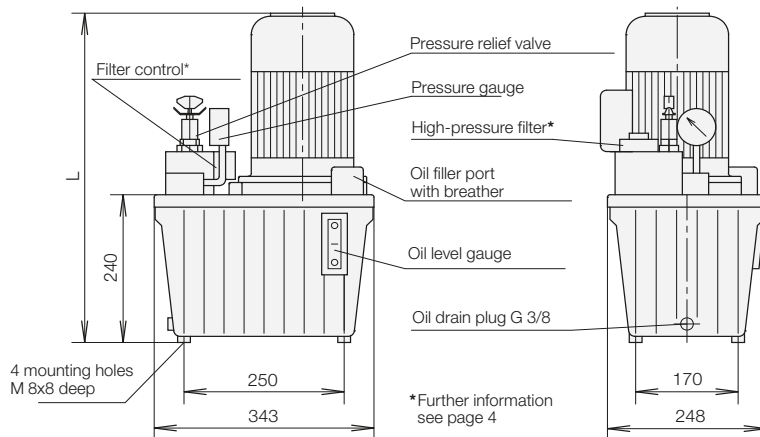

Electrical data

Motor voltage	3/PE 50 Hz 230/400 V
Code class	IP 54
Relative duty cycle (%ED)	(The ratio between duty cycle (ED) and cycle time (SD))

The calculation of the relative duty cycle (%ED) is based on a cycle time (SD) of 10 minutes. With 40% ED, e.g. the maximum load within the cycle should not exceed 4 min. Different versions on request: Other data see chart and data sheet A 0.100.

Note to figure and hydraulic circuit diagram

The pressure switch, oil level and oil temperature control and filter control shown in the above figure are not supplied with the basic version of the power unit, see page 4.

Part no.

Electronic system pressure switch	9740-050
Oil level and oil temperature control	3822-008

Hydraulic circuit diagram

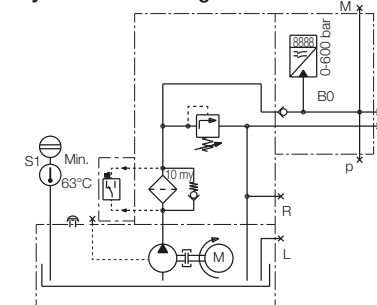

Flow rate	Operating pressure at 100% ED ¹⁾	Nominal rating	L ²⁾	Weight	Part no. Basic version	Part no. with filter control ³⁾		
							ccm/s	l/min
15	0.9	350	500	0.75	489	27	8223-310	8223-910
25	1.5	150	200	0.75	489	27	8122-300	8122-900
25	1.5	360	500	1.1	504	30	8223-308	8223-908
86/12	5.2+0.7	100/500	100/500	0.75	489	29	8223-325	8223-925
41	2.5	220	300	1.1	504	30	8223-311	8223-911
70	4.5	64	85	0.75	489	27	8142-300	8142-900
70	4.5	104	142	1.1	504	30	8143-300	8143-900
70	4.5	142	180	1.5	531	34	8144-300	8144-900
102	6.2	50	65	0.75	489	27	8152-300	8152-900
102	6.2	73	100	1.1	504	30	8153-300	8153-900
102	6.2	100	125	1.5	531	34	8154-300	8154-900

1) Refers only to the electric motor. The running time of the pump at max. pressure depends on the occurring power losses. Please note that the oil temperature does not exceed 70 °C.

2) The mounting height (dimension L) of the power units depends on the type of motors used.

3) Explanations of filter control see page 4.

Valve control up to 500 bar

Single acting without and with machine tool interlock

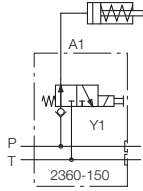

Single acting with 1 off 3/2 directional control valve, clamped in de-energised mode

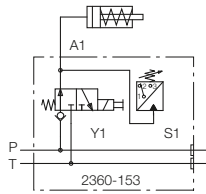

Single acting with 1 off 3/2 directional control valve and machine tool interlock, clamped in de-energised mode

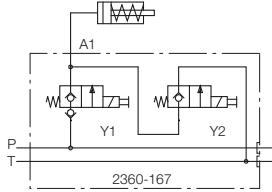

Single acting with 2 off 2/2 directional control valves, safe in de-energised mode

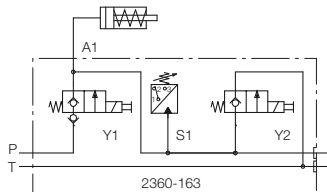

Single acting with 2 off 2/2 directional control valves and machine tool interlock, safe in de-energised mode

Double acting without and with machine tool interlock

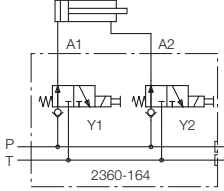

Double acting with 2 identical 3/2 directional control valves, which are alternately pressurised

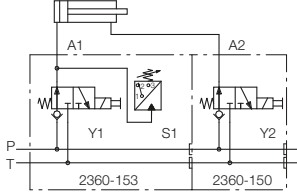

Double acting with 2 identical 3/2 directional control valves, which are alternately pressurised and machine tool interlock

Double acting with 2 different valve positions without and with machine tool interlock

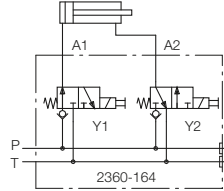

Double acting with 2 inverse 3/2 directional control valves, which are simultaneously pressurised

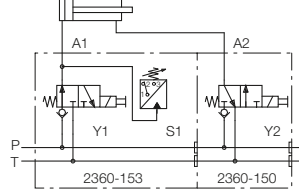

Double acting with 2 inverse 3/2 directional control valves, which are simultaneously pressurised and machine tool interlock

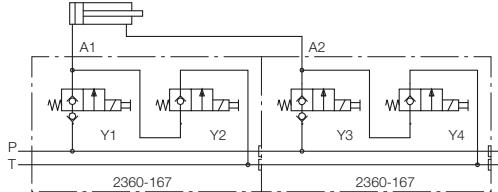

Double acting with 4 off 2/2 directional control valves, safe in de-energised mode

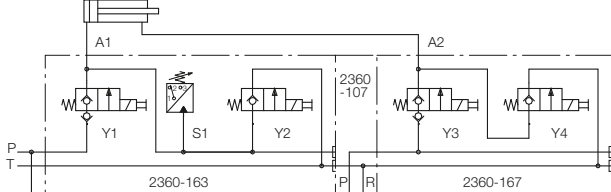

Double acting with 4 off 2/2 directional control valves and machine tool interlock, safe in de-energised mode

With 4/3 directional control valves, max. 350 bar

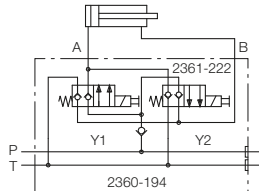

2360-194 Double acting with 4/3 directional control valve, safe in de-energised mode

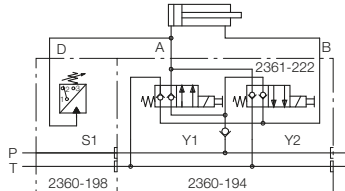

2360-194 Double acting with 2/3 directional control valve and machine tool interlock, safe in de-energised mode

Accessories

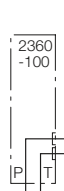

2360-100 Entry plate

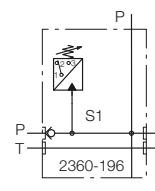

2360-196 Pressure switch plate with check valve

Special switchings

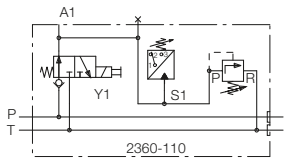

2360-110 Series mounting plate with pressure switch for machine tool interlock and pressure relief valve to limit the pressure in the case of temperature increase (e.g. wedge clamping elements).

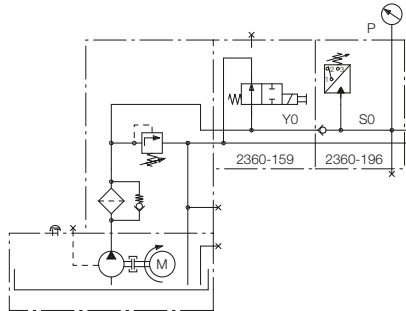

Power unit with pressure switch for unpressurised cycle in connection with 2/2 directional control valves ND4.

Circuit examples

Preset pressure:
for double-acting cylinders

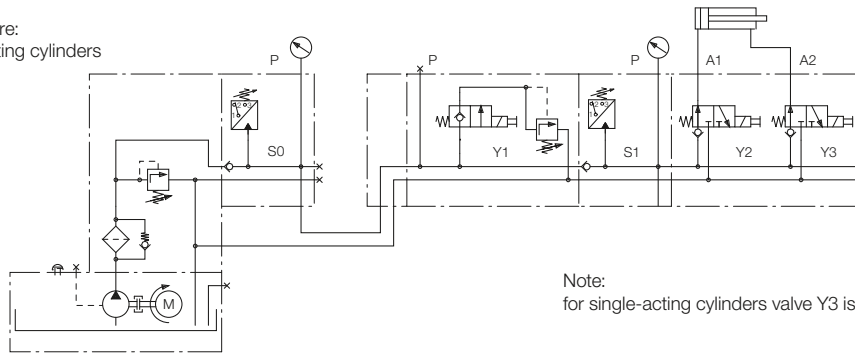

Note:
for single-acting cylinders valve Y3 is not required

Finish pressure:
for double-acting cylinders

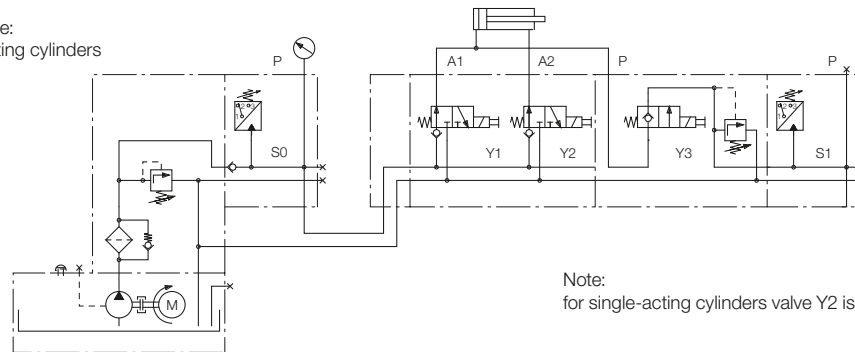

Note:
for single-acting cylinders valve Y2 is not required

2 pressure ranges:
for double-acting cylinders

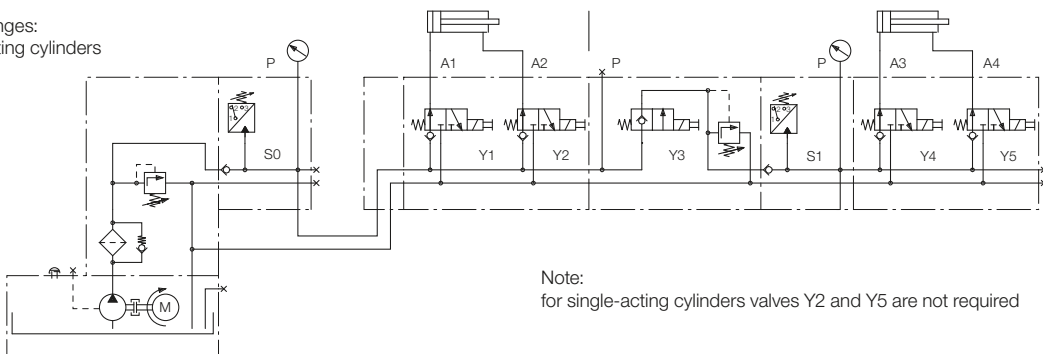

Note:
for single-acting cylinders valves Y2 and Y5 are not required

Power unit

Valve switchings with spool valve as per data sheet C 2.530 up to max. 315 bar

1. Mounting plates

No. 2450-111	Adaptor plate
No. 2450-100	Mounting plate for single valves G 1/4
No. 2450-500	Mounting plate for unpressurised cycle with 4/2 directional control valve

2. Valves

4/2 and 4/3 directional control valves ND 6 with 24 V DC.
Solenoids as per data sheet C 2.530.

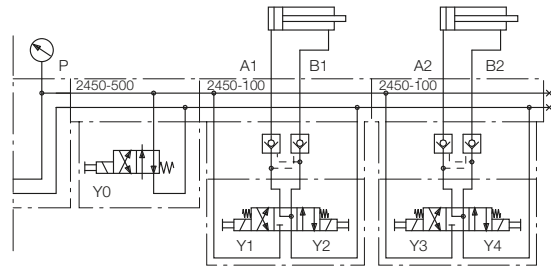
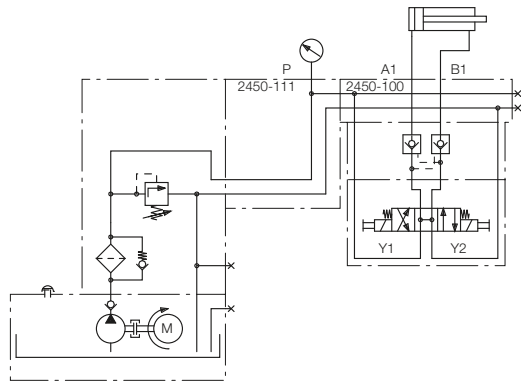

Explanations of high-pressure filter

Application

The reliability of a hydraulic system depends for the most part on the cleanness of the hydraulic fluids. It is the task of a high-pressure filter to clean the returning oil from fixtures, etc., which is contaminated (from piping, assembly dirt, etc.), before it will flow again through the hydraulic components of the system (valves, etc.). Thereby the contamination rate is reduced to a minimum, and the individual elements are protected against premature wear.

Description

The high-pressure filter is installed directly behind the pump in the pressure line of the power unit (see hydraulic circuit diagram). The filter has a bypass valve to avoid troubles of functioning in case of blocked filter pores.

Through the bypass valve, the hydraulic fluid can enter unfiltered into the system. To prevent this, it is advisable to provide a filter control (see accessory).

Change of the filter cartridge can be made efficiently, being located in the connecting block of the power unit.

Technical data

Max. operating pressure	500 bar
Differential pressure constancy	up to 30 bar
Filtration level	10 µm
Spare filter cartridge	
Part no.	3887-107

Explanations of filter control

Use

Electrical signal for filter contamination in the high-pressure filter of the power unit.

Description

Due to the contamination of the high-pressure filter the cross section for the oil flow becomes smaller and smaller. Thereby the pressure in front of the filter element increases.

To monitor the pressure increase the pressure in front of and behind the oil filter is measured. The filter control is pressurised with both pressures. Due to the rising differential pressure a spring-loaded piston in the interior of the element is displaced and operates a limit switch which can trigger switching processes. On static conditions (no oil flow) of the system, the piston and the switch return to its initial position.

Electric circuit diagram

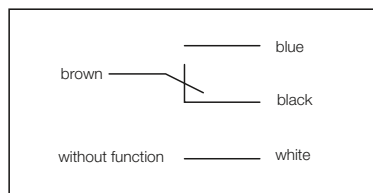

Note for switch setting

Screw in the switch or limit switch into the housing, until the contact between the brown and the black conductor (see circuit diagram) will be closed and then rotate again by 360 degree. Tighten and lock the nuts.

Technical data

Max. operating pressure	500 bar
Reaction differential pressure	10 bar ±10%
Type of indication	electrical
Type of contact	change-over relay
Connection	plug
Code class	IP 67
Switching potential 250 V AC	
40 – 60 Hz	0,2 A
Switching potential 24 V DC	0,05 A
Switching voltage	min. 12 V DC
Switching current at 12 V DC	min. 10 mA
Line cross section	4 x 0,5 mm ²
Line length	2 m