

Electric Drives  
and Controls

Hydraulics

Linear Motion and  
Assembly Technologies

Pneumatics

Service

**Rexroth**  
Bosch Group

1/12

## 4/3, 4/2 and 3/2 directional valve with fluidic actuation

RE 22282-XC-B2/07.09

Type WP 6...XC, WH 6...XC

Size 6  
Component series 6X (WP), 5X (WH)  
Maximum operating pressure 315 bar  
Maximum flow 60 l/min

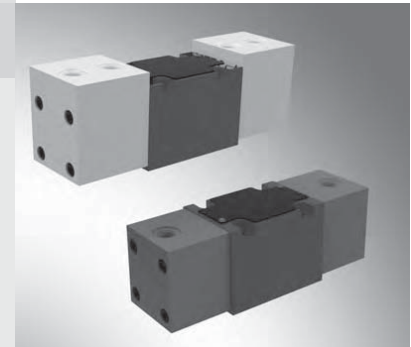

**ATEX devices**  
For explosive areas

Part II Technical data sheet



### Explosion protection information:

Area of application according to explosion protection directive and ignition protection type

- Area of application according to directive 94/9/EC **IM2, II2G, II2D, II3G, II3D**
- Ignition protection type of the valve: c (EN 13463-5:2004-03)

### What you should know about these operating instructions

These operating instructions apply to Rexroth valves in explosion-proof design and consist of the following three parts:

- Part I General information RE 07010-X-B1
- Part II Technical data sheet RE 22282-XC-B2
- Part III Product-specific instructions RE 22282-XC-B3

RE 22282-XC-B0

Further information regarding the correct handling of hydraulic products of Rexroth is contained in our publication "General product information on hydraulic products" RE 07008.

## Table of contents

Contents	Page
Features	2
Ordering code and scope of delivery	2
Spool symbols	3
Types of actuation	4
Function, section	5
Technical data	6
Explosion protection information	6
Characteristic curves	7
Performance limits	8, 9
Unit dimensions	10, 11

## Features

- Direct operated directional spool valve for the intended use in explosive atmospheres
- Actuating elements:
  - Pneumatic (WP)
  - Hydraulic (WH)
- Porting pattern according to DIN 24340 form A (without locating hole)
- Porting pattern according to ISO 4401-03-02-0-05 (with locating hole)

## Ordering code and scope of delivery

	W	6	/	XC			
3 main connections = 3							
4 main connections = 4							
Directional valve = W							
<b>Type of actuation</b>							
Pneumatic = P							
Hydraulic = H							
Connections radial = No code							
Size 6 = 6							
Spool symbols e.g. C, E, EA, EB, etc.							
Possible designs see page 3							
<b>Type WP</b>							
Component series 60 to 69 = 6X (60 to 69: unchanged installation and connection dimensions)							
<b>Type WH</b>							
Component series 50 to 59 = 5X (50 to 59: unchanged installation and connection dimensions)							
with spring return = No code							
without spring return = O							
without spring return, with detent = OF							
without manual override = No code							
with manual override = N <sup>1)</sup>							

**No code** = without locating hole  
/60 <sup>3)</sup> = with locating hole  
/62 = with grooved pin

**Seal material**  
No code = NBR seals  
V = FKM seals  
Note:  
Observe compatibility of seals with hydraulic fluid used!

**No code** = without throttle insert  
B08 <sup>2)</sup> = Throttle Ø 0.8 mm  
B10 <sup>2)</sup> = Throttle Ø 1.0 mm  
B12 <sup>2)</sup> = Throttle Ø 1.2 mm

**XC** = Valve in explosion-proof design, for details see explosion protection information page 6

<sup>1)</sup> Only with pneumatic actuation "P"  
<sup>2)</sup> Application in case of flow > performance limit of the valve, effective in channel P.  
<sup>3)</sup> Grooved pin ISO 8741-3x8-St-A2C, Material no. **R900005076** (separate order)

	Spool positions		Spool positions	
	2 pos.	3 pos.	Type WP	Type WH
<b>No code</b>	•	•	•	•
<b>O</b>	•		•	•
<b>OF</b>	•		•	•

• = Available

**Included in the scope of delivery:**  
Valve operating instructions with declaration of conformity in part III

## Spool symbols

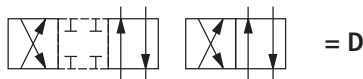
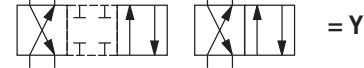
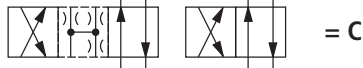
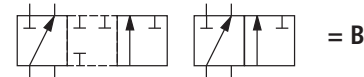
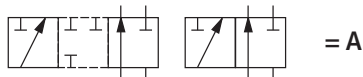
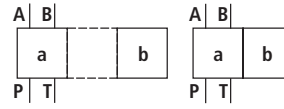
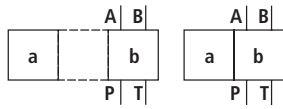

1) Example:

- Spool E with spool position "a" → ordering code ..EA..
- Spool E with spool position "b" → ordering code ..EB..

2) Symbol E1-: P → A/B pre-opening

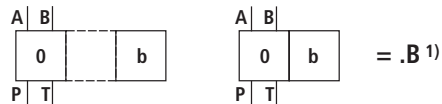

Be careful because of the pressure intensification with single-rod cylinders!

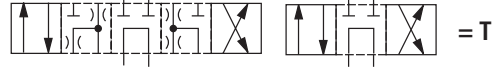
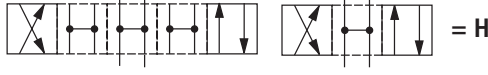
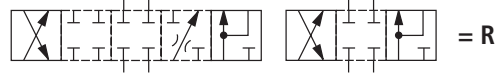
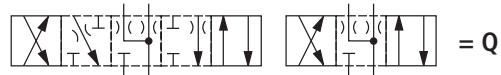
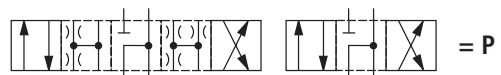
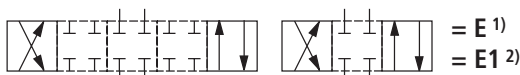
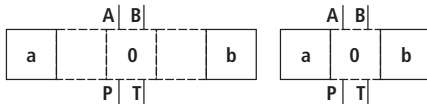

## Types of actuation

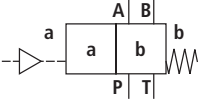
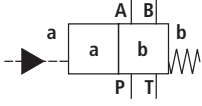
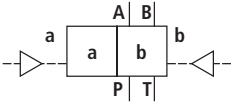
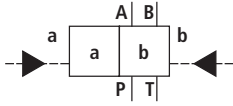
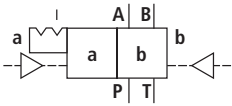
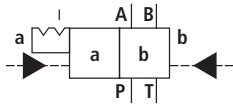
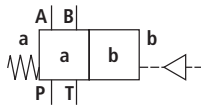
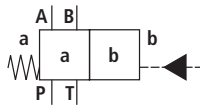
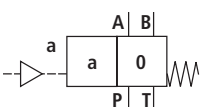
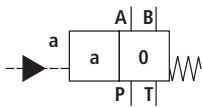
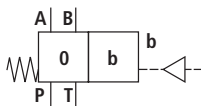
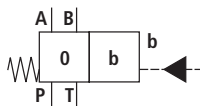
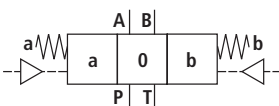
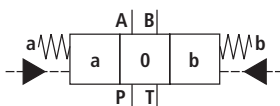
Spool symbol	Ordering code		Type of actuation	
	Actuation side	Spool return	P (pneumatic)	H (hydraulic)
A, C, D				
		../O..		
		../OF..		
B, Y				
E, E1, F G, H J, L M, P Q, R T, U V, W	"a" <sup>1)</sup> = .A			
	"b" <sup>1)</sup> = .B			
				

<sup>1)</sup> See spool symbols page 3.

## Function, section

### General

Valves of type WP 6...XC and WH 6...XC are fluidically actuated directional spool valves. They control the start, stop and direction of a flow.

The directional valves basically consist of housing (1), one or two actuating elements (2) (hydraulic, pneumatic actuating cylinder), the control spool (3), and one or two return springs (4). The control connections are arranged radially (type 4WP) (5). The bleeding connections (6) must be established and led to a place outside the explosive area.

In the de-energized condition, control spool (3) is held in the central or initial position by the return springs (4) (except for impulse spool).

By means of the actuating elements, the control spool (3) is pushed in the desired spool position.

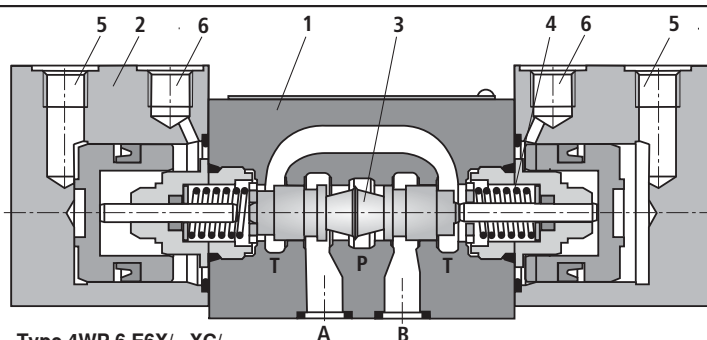

Type 4WP 6 E6X/...XC/...

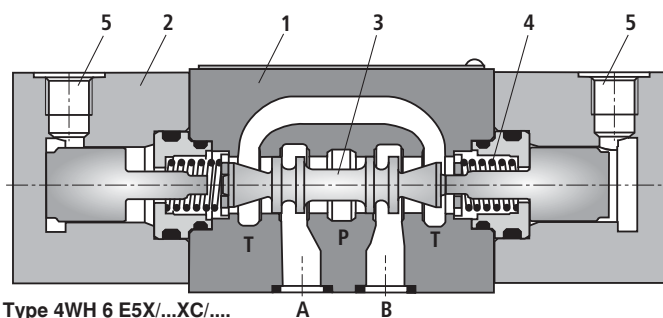

Type 4WH 6 E5X/...XC/...

### Throttle insert

The use of a throttle insert is required when due to prevailing operating conditions, flows can occur during the switching processes that are higher than the performance limit of the valve.

It is inserted in channel P of the directional valve.

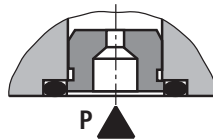

### Without spring return, with detent, version ..OF/..

Directional valves with hydraulic or pneumatic actuation are also available as 2-spool position valve with detent (7). When using actuating elements with detent, each spool position can be fixed.

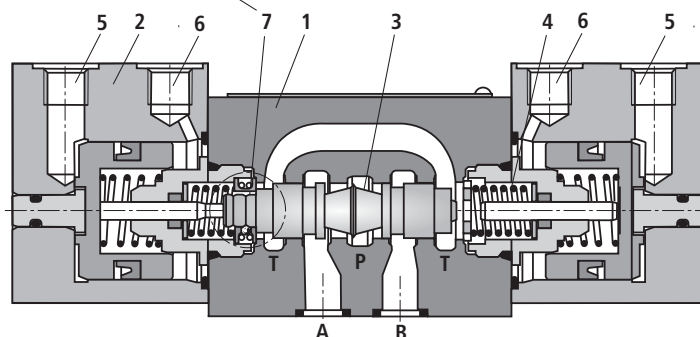
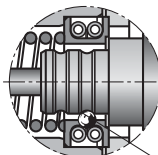

Type 4WP 6 C6X/OF/N...XC/...

### Without spring return, version ..O/..

When using actuating elements without spring return and without detent, there is no defined spool position in the de-energized condition.

## Technical data

### general

Valve type		WP	WH
Weight	- Valve with one actuating cylinder	kg	approx. 1.8
	- Valve with two actuating cylinders	kg	approx. 2.0
Installation position		Any <sup>1)</sup>	
Ambient temperature range	°C	-30 ... +80 (NBR seals) -20 ... +80 (FKM seals)	

### hydraulic

Maximum operating pressure	- Port A, B, P	bar	315
	- Port T	bar	160 With symbols A or B, port T must be used as leakage port if the operating pressure exceeds the admissible tank pressure. <b>2 bar minimum pre-load pressure required.</b>
Maximum flow		l/min	60
Flow cross-section (Spool position 0)	- with spool symbol Q		6 % of nominal cross-section
	- with spool symbol W		3 % of nominal cross-section
Minimum control pressure <sup>8)</sup>		bar	4 (see characteristic curve page 7)   6 to 10 > tank pressure <sup>2)</sup>
Maximum control pressure <sup>8)</sup>		bar	10   200
Control volume		cm <sup>3</sup>	4.24   1.23
Hydraulic fluid			Mineral oil (HL, HLP) according to DIN 51524 <sup>3)</sup> ; quickly bio-degradable hydraulic fluids according to VDMA 24568 (see also RE 90221); HETG (rape seed oil) <sup>3)</sup> ; HEPG (polyglycols) <sup>4)</sup> ; HEES (synthetic esters) <sup>4)</sup> ; HFC according to ISO 12922 <sup>5)</sup> ; other hydraulic fluids upon request
Hydraulic fluid temperature range	°C		-30 ... +80 (NBR seals) -20 ... +80 (FKM seals)
Viscosity range	mm <sup>2</sup> /s		2.8 to 500
Maximum permitted degree of contamination of the hydraulic fluid - cleanliness class according to ISO 4406 (c)			Class 20/18/15 <sup>6)</sup>
Maximum switching frequency		1/h	7,200

## Explosion protection information

Area of application according to directive 94/9/EC		IM2; II2G; II2D; II3G; II3D
Ignition protection type Valve		c (EN 13463-5:2004-03)
Maximum surface temperature <sup>7)</sup>	°C	100
Temperature class <sup>7)</sup>		T4
Special conditions for a safe use		
Ambient temperature range	°C	-20 ... +80

<sup>1)</sup> With version ../O.. (A, C, and D): horizontal

<sup>2)</sup> Performance limits depending on the minimum control pressure, see page 9

<sup>3)</sup> Suitable for NBR **and** FKM seals

<sup>4)</sup> Suitable **only** for FKM seals

<sup>5)</sup> Suitable **only** for NBR seals

<sup>6)</sup> The cleanliness classes specified for the components must be adhered to in hydraulic systems. Effective filtration prevents faults and at the same time increases the service life of the components. For the selection of filters, see data sheets RE 50070, RE 50076, RE 50081.

<sup>7)</sup> The specified max. temperature or temperature class refers to the max. permitted fluid and ambient temperature. A max. pressure drop across the valve results in a surface temperature 20 K above the fluid temperature, i.e. application in T6 is possible if the fluid and ambient temperature is max. 60 °C.

**Note:**

The ignition temperature of the hydraulic fluid used must be 50 K higher than the surface temperature of the valve.

<sup>8)</sup> With type WP: Control air must be free from oil to the largest possible extent or the oil content in the control air must be clearly below the explosion limit.

## Characteristic curves (measured with HLP46, $\vartheta_{oil} = 40^\circ\text{C} \pm 5^\circ\text{C}$ )

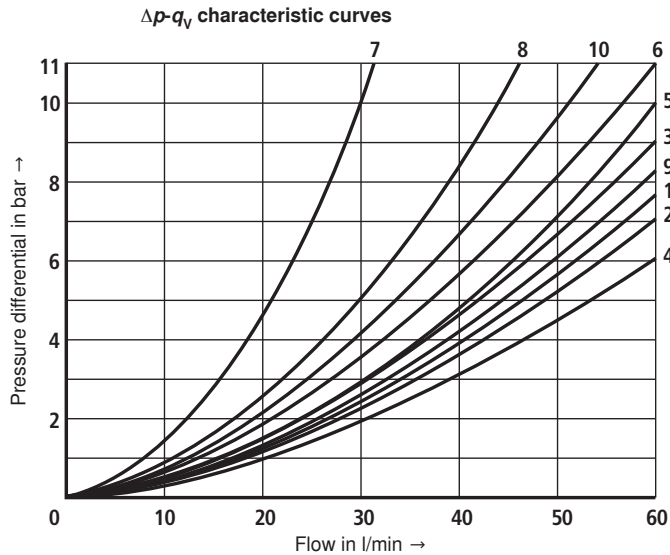

Spool symbols	Flow direction			
	P-A	P-B	A-T	B-T
A	3	3	-	-
B	3	3	-	-
C	1	1	3	1
D	5	5	3	3
E	3	3	1	1
F	1	3	1	1
G	6	6	9	9
H	2	4	2	2
J	1	1	2	1
L	3	3	4	9
M	2	4	3	3
P	3	1	1	1
Q	1	1	2	1
R	5	5	4	-
T	10	10	9	9
U	3	3	9	4
V	1	2	1	1
W	1	1	2	2
Y	5	5	3	3

### More characteristic curves:

- 7 Spool symbol "R" in spool position "b" (B → A)
- 8 Spool symbols "G" and "T" in central position (P → T)
- 9 Spool symbol "H" in central position P → T)

### Minimum control pressure depending on the tank pressure

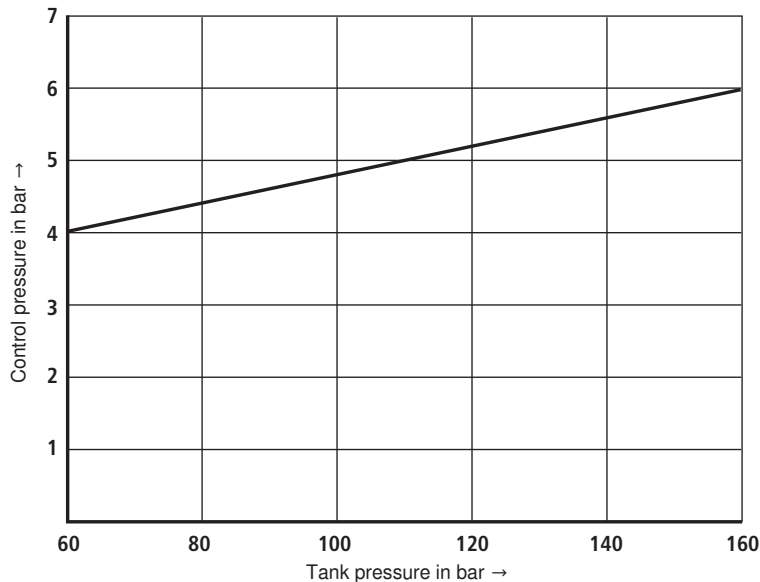

With a higher tank pressure, the minimum control pressure must be increased according to this diagram.

**Performance limits: Type WP 6...XC (measured with HLP46,  $t_{oil} = 40^\circ\text{C} \pm 5^\circ\text{C}$ )**

Due to the adhesive effect, the switching function of the valves depends on the filtration. For achieving the specified, admissible flow values, full flow filtration with  $25\ \mu\text{m}$  is recommended. The flow forces acting within the valves also influence the flow performance.

With 4-directional valves, the specified flow data thus applies for the normal use with 2 flow directions (e.g. from P to A and simultaneous return flow from B to T).

If there is only one direction of flow, the admissible flow may be considerably lower in critical cases (e.g. when using a 4-directional valve as 3-directional valve by blocking port A or B).

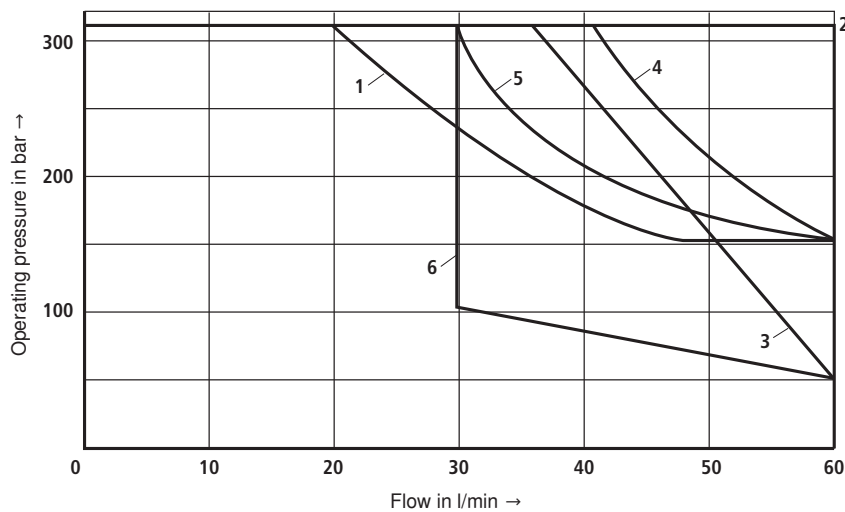

Character-istic curve	Spool symbol
1	A, B
2	A/O, C, C/O, D, D/O, E, E1-, G, H, J, L, M, Q, U, W, and Y
3	F, P
4	R
5	T
6	V

## Performance limits: Type WH 6...XC (measured with HLP46, $\vartheta_{oil} = 40^\circ\text{C} \pm 5^\circ\text{C}$ )

Due to the adhesive effect, the switching function of the valves depends on the filtration. For achieving the specified, admissible flow values, full flow filtration with  $25\ \mu\text{m}$  is recommended. The flow forces acting within the valves also influence the flow performance.

With 4-directional valves, the specified flow data thus applies for the normal use with 2 flow directions (e.g. from P to A and simultaneous return flow from B to T).

If there is only one direction of flow, the admissible flow may be considerably lower in critical cases (e.g. when using a 4-directional valve as 3-directional valve by blocking port A or B).

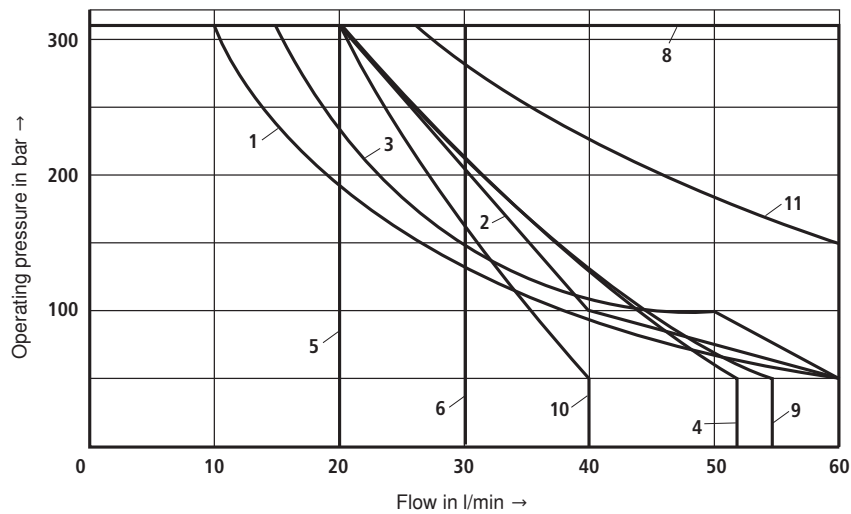

Control pressure 6 bar > tank pressure		
Spring return	Characteristic curve	Spool symbol
"No code" (with spring return)	1	A, B
	2	C, D, Y
	3	E, J, L, U, M, Q, V, W, E1-
	4	F, P
	5	T
	6	G, H
	7	R
../O..	8	A, C, D
../OF..	8	A, C, D

Control pressure 10 bar > tank pressure		
Spring return	Characteristic curve	Spool symbol
"No code" (with spring return)	1	A, B
	8	C, D, Y, E, G, H, J, L, U, M, Q, V, W, E1-
	9	F, P
	10	R
	11	T
../O..	8	A, C, D
../OF..	8	A, C, D

**Unit dimensions: Type WP 6...XC (dimensions in mm)**

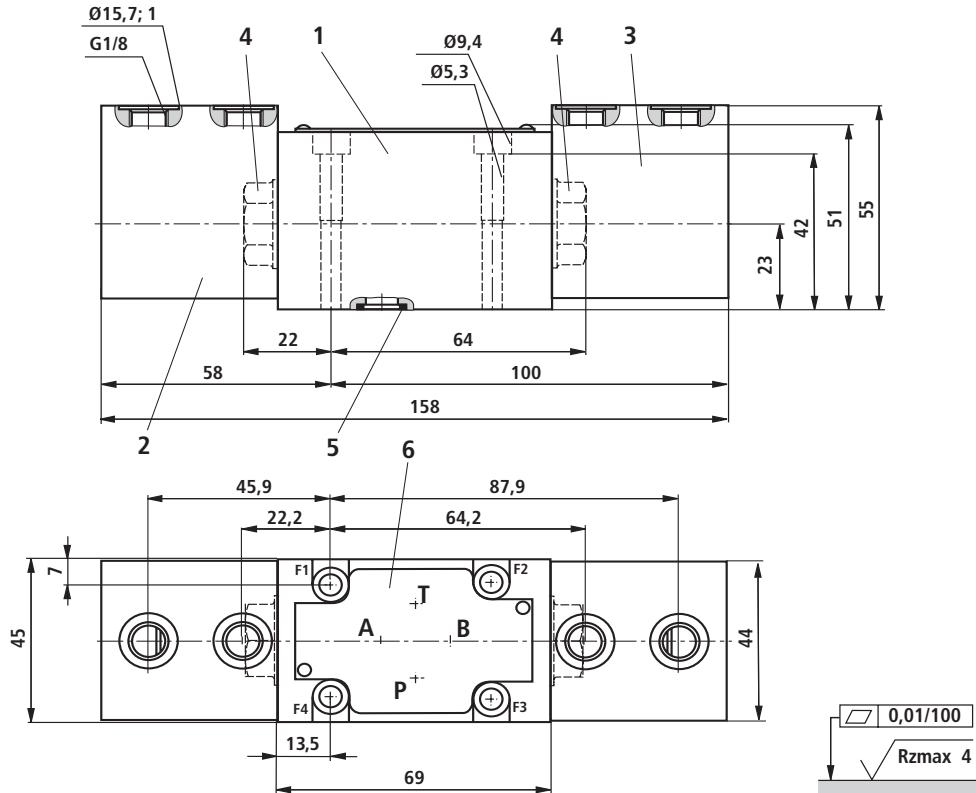

Required surface quality of the valve mounting face

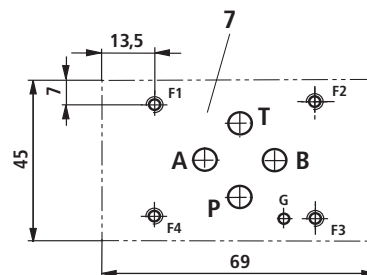

- 1 Valve with 2 spool positions and 2 actuating cylinders  
Valve with 3 spool positions and 2 actuating cylinders
- 2 Actuating cylinder "a"
- 3 Actuating cylinder "b"
- 4 Plug screw for valve with one actuating cylinder (2 spool positions)
- 5 Identical seal rings for ports A, B, P, T
- 6 Nameplate
- 7 Porting pattern according to DIN 24340 form A (without locating hole), or ISO 4401-03-02-0-05 (with locating hole)

**Valve mounting screws**

For reasons of stability, only the following valve mounting screws may be used:

**4 hexagon socket head cap screws**  
**ISO 4762-M5x50-10.9-fZn-240h-L**

(friction coefficient 0.09–0.14 according to VDA 235-101)

Material no. R913000064

(must be ordered separately)

**Unit dimensions: Type WH 6...XC (dimensions in mm)**

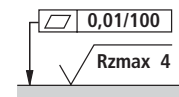
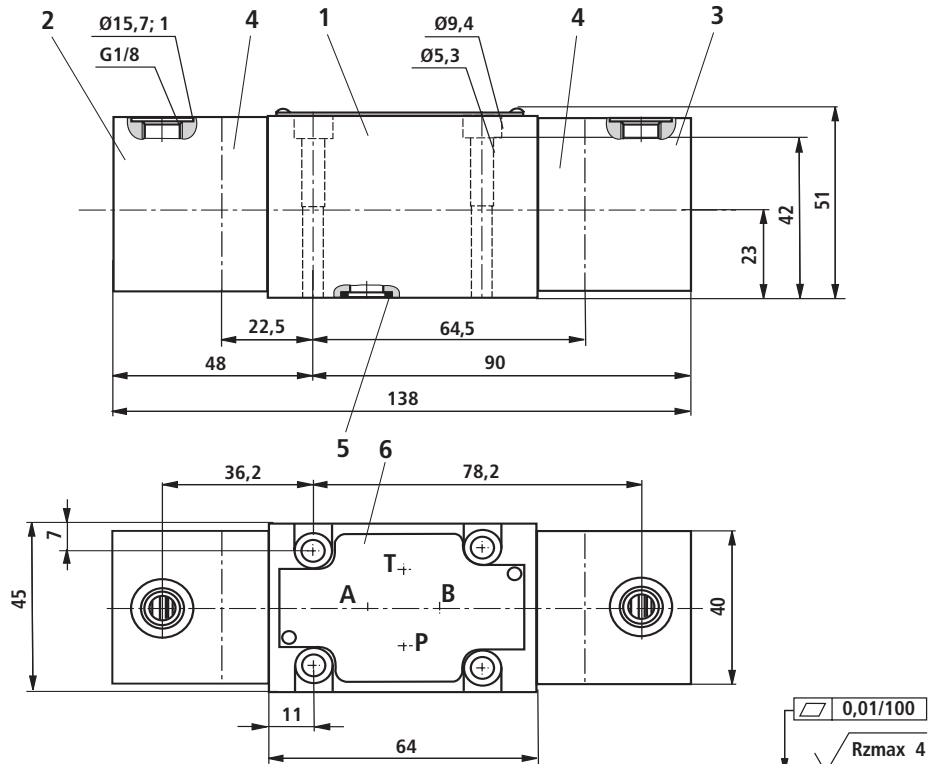

Required surface quality of the valve mounting face

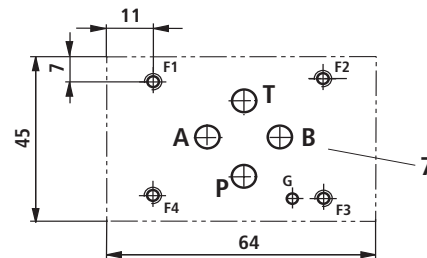

- 1 Valve with 2 spool positions and 2 actuating cylinders  
Valve with 3 spool positions and 2 actuating cylinders
- 2 Actuating cylinder "a"
- 3 Actuating cylinder "b"
- 4 Cover for valve with one actuating cylinder (2 spool positions)
- 5 Identical seal rings for ports A, B, P, T
- 6 Nameplate
- 7 Porting pattern according to DIN 24340 form A (without locating hole), or ISO 4401-03-02-0-05 (with locating hole)

**Valve mounting screws**

For reasons of stability, only the following valve mounting screws may be used:

**4 hexagon socket head cap screws**

**ISO 4762-M5x50-10.9-fIZn-240h-L**

(friction coefficient 0.09–0.14 according to VDA 235-101)

Material no. R913000064

(must be ordered separately)

## Notes

---

© This document, as well as the data, specifications and other information set forth in it, are the exclusive property of Bosch Rexroth AG. It may not be reproduced or given to third parties without its consent. The data specified above only serve to describe the product. No statements concerning a certain condition or suitability for a certain application can be derived from our information. The information given does not release the user from the obligation of own judgment and verification. It must be remembered that our products are subject to a natural process of wear and aging.