

The Drive & Control Company

Rexroth
Bosch Group

4/3 proportional directional valve with integrated digital electronics and field bus interface (IFB-P)

Type 4WREF

RE 29048

Edition: 2014-01

Replaces: 02.13



- ▶ Sizes 6 and 10
- ▶ Component series 2X
- ▶ Maximum operating pressure 315 bar
- ▶ Maximum flow: 80 l/min (size 6)
- ▶ Maximum flow: 180 l/min (size 10)

Features

- ▶ Direct operated proportional directional valve with integrated digital electronics and field bus interface (Integrated Field Bus IFB-P)
- ▶ Operation by means of proportional solenoids with central thread and detachable coil
- ▶ Position-controlled valve control spool
- ▶ Analog interface for command and actual value
- ▶ Command value (flow) analog or via bus
- ▶ Design for CAN bus with CANopen protocol DS 408 or Profibus-DP
- ▶ Quick commissioning via PC and WIN-PED 6 commissioning software

Contents

Features	1
Ordering code	2
Symbols	3
Function, section	4, 5
Technical data	5, 6
Integrated electronics (IFB-P)	7 ... 9
Characteristic curves	10 ... 15
Dimensions	16 ... 18
Accessories	19 ... 20
Additional information	21

Bosch Rexroth AG, RE 29048, version: 2014-01

2/22 **4WREF** | Proportional directional valve with integrated, digital electronics

Ordering code

01	02	03	04	05	06	07	08	09	10	11	12	
4	WRE	F				2X	/	V	-	24		*

01	4 main ports	4
02	Proportional directional valve	WRE
03	With integrated digital electronics and field bus interface	F
04	Size 6	6
	Size 10	10
05	Symbols e.g. E, E1, V etc.: possible design see page 3	

Rated flow for size 6

06	8 l/min	08
	16 l/min	16
	32 l/min	32

Rated flow for size 10

06	25 l/min	25
	50 l/min	50
	75 l/min	75

07	Component series 20 ... 29 (20 ... 29: Unchanged installation and connection dimensions)	2X
08	FKM seals	V
09	Supply voltage 24 V	24

Bus interface

10	CANBus DS 408	C
	Profibus DP V0/V1	P

Electrical interface

11	Command value ± 10 V	A1
	Command value 4 to 20 mA	F1
12	Further details in the plain text	

Bosch Rexroth AG, RE 29048, edition: 2014-01

Symbols

Type 4WREF...E...

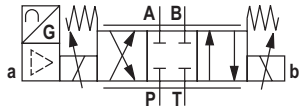

Type 4WREF...W...

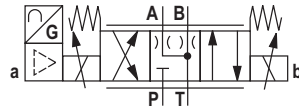

Type 4WREF...V...

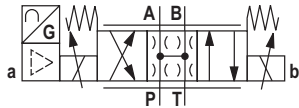

Control spool symbols

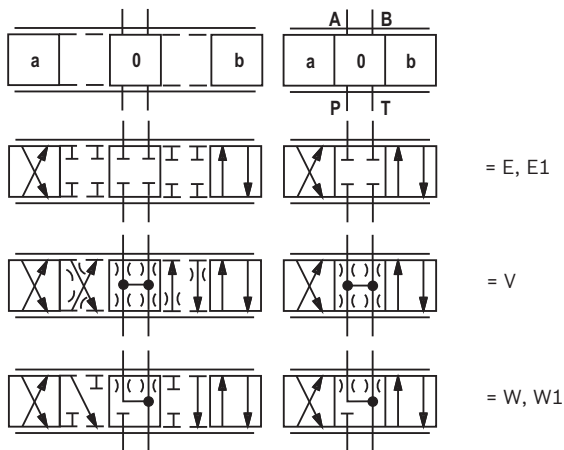

With symbols E1 and W1:

P → A: q_{vmax} B → T: $q_v/2$
 P → B: $q_v/2$ A → T: q_{vmax}

4/22 **4WREF** | Proportional directional valve with integrated, digital electronics

Function, section

Set-up

The valve basically consists of:

- Housing (1) with connection surface
- Control spool (2) with compression springs (3 and 4) and spring plates (8 and 9)
- Coils (5 and 6) and pole tubes (10 and 11) with central thread
- Position transducer (7)
- Integrated digital control electronics IFB-P (12)

Functions:

- Control of the valve spool position
- The command value can alternatively be specified via an analog interface (X1) or via the field bus interface (X2, X3).
- The actual value signals are provided via an analog interface (X1) and can additionally be read out via the field bus (X2, X3).
- The controller parameters are set via the field bus.

Functional description

With de-energized solenoids (5 and 6), the control spool (2) is brought into the central position by the compression springs (3 and 4) between the spring plates (8 and 9) (with V control spool without spring plate). With V control spools, the mechanical zero position does not correspond to the hydraulic one.

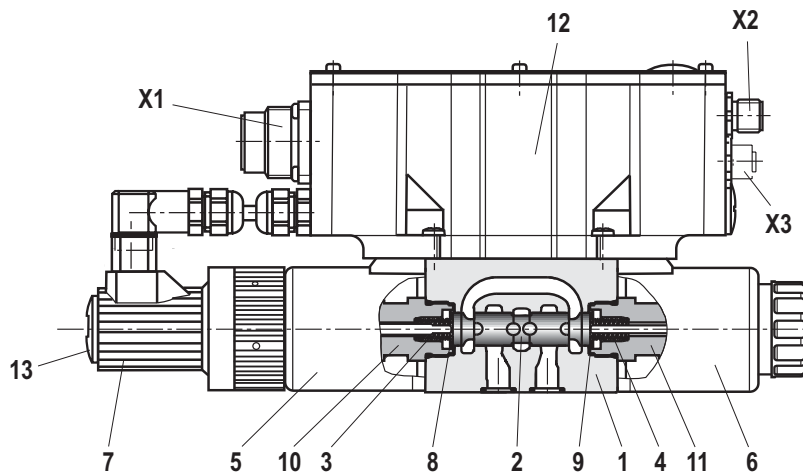

Notice! The PG fitting (13) must not be opened. Mechanical adjustment of the adjustment nut located below is prohibited and damages the valve!

Notice! Due to the design principle, internal leakage is inherent to the valves and may increase over the life cycle.

The tank line must not be allowed to run empty. With corresponding installation conditions, a preload valve is to be installed.

Bosch Rexroth AG, RE 29048, edition: 2014-01

Function, section

The integrated digital electronics enables the following fault detection:

- Undervoltage
- Cable break in position transducer (7)
- Communication error
- Watchdog
- Cable break in command value input (only with current interface)

The following additional functions are available:

- Ramp generator
- Internal command value profile
- Enable function, digital
- Overlap compensation
- Zero point correction

WIN-PED PC program (version 6 or higher):

To implement the project planning task and to parameterize the IFB-P valves, the user may use the WIN-PED commissioning software.

- Parameterization
- Diagnosis
- Convenient data management on a PC

System requirements

- IBM PC or compatible system
- Windows 2000 or Windows XP
- RAM (recommendation: 256 MB)
- 150 MB of available hard disk capacity

Notice

The "WIN-PED" PC program is not included in the scope of delivery. It can be downloaded on the Internet free of charge! (See page 18)

Technical data

(for applications outside these parameters, please consult us!)

general		Size 6	Size 10
Installation position		Any, preferably horizontal	
Storage temperature range	°C	-20 ... +80	
Ambient temperature range	°C	-20 ... +50	
Weight without sandwich plate	kg	2.4	6.5
MTTFd values according to EN ISO 13849	Years	150 (for further details see data sheet 08012)	
Climate		Environmental audit according to EN 60068-2	
hydraulic (measured with HLP46, $\vartheta_{oil} = 40\text{ °C} \pm 5\text{ °C}$)			
Maximum operating pressure	- Ports A, B and P	bar Up to 315	
	- Port T	bar Up to 210	
Rated flow q_{Vnom} with $\Delta p = 10\text{ bar}$	l/min	8	25
		16	50
		32	75
Maximum admissible flow	l/min	80	180
Hydraulic fluid		See table page 6	
Hydraulic fluid temperature range	°C	-20 ... +70, preferably +40 ... +50	
Viscosity range	mm ² /s	20 to 380, preferably 30 to 46	
Maximum admissible degree of contamination of the hydraulic fluid, cleanliness class according to ISO 4406 (c)		Class 20/18/15 ¹⁾	
Hysteresis (position control - valve control spool)	%	≤ 0.1	
Range of inversion (position control - valve control spool)	%	≤ 0.05	
Response sensitivity (position control - valve control spool)	%	≤ 0.05	
Zero shift valve control spool upon change of hydraulic fluid temperature and operating pressure	%/10K	< 0.15	
	%/100 bar	< 0.1	

¹⁾ The cleanliness classes specified for the components must be adhered to in hydraulic systems. Effective filtration prevents faults and at the same time increases the life cycle of the components. For the selection of the filters, see www.boschrexroth.com/filter.

6/22 4WREF | Proportional directional valve with integrated, digital electronics

Technical data

(for applications outside these parameters, please consult us!)

Hydraulic fluid	Classification	Suitable sealing materials	Standards
Mineral oils and related hydrocarbons	HL, HLP	NBR, FKM	DIN 51524
 Important information on hydraulic fluids! <ul style="list-style-type: none"> ▶ For more information and data on the use of other hydraulic fluids, refer to data sheet 90220 or contact us! ▶ There may be limitations regarding the technical valve data (temperature, pressure range, life cycle, maintenance intervals, etc.)! ▶ The flash point of the hydraulic fluid used must be 40 K higher than the maximum solenoid surface temperature. 			

electric			
Duty cycle ¹⁾		%	100
Supply voltage	- Nominal voltage	VDC	24
	- Lower limit value	VDC	19.4
	- Upper limit value	VDC	35
	- Maximum admissible residual ripple	Vpp	2
Total current consumption	- I_{max}	A	2
	- Impulse current	A	3
Command and actual value signals	- Voltage "A1"	V	±10
	- Current "F1"	mA	4 to 20
Converter resolution (command/actual value signals)		Bit	10
Maximum coil temperature ²⁾		°C	Up to 150
Protection class of the valve according to EN 60529	IP 65 with mounted and locked plug-in connectors		
EMC (electromagnetic compatibility)	Interference resistance prEN 50082-2:1994		
	Interference emission EN 50081-1:1992		

¹⁾ Connect the valve to the supply voltage only when this is required for the functional processes of the machine.

²⁾ Due to the temperatures occurring at the surfaces of the solenoid coils, the European standards ISO 13732-1 and EN ISO 4413 must be adhered to.

Integrated electronics (IFB-P), marking and adjustment elements

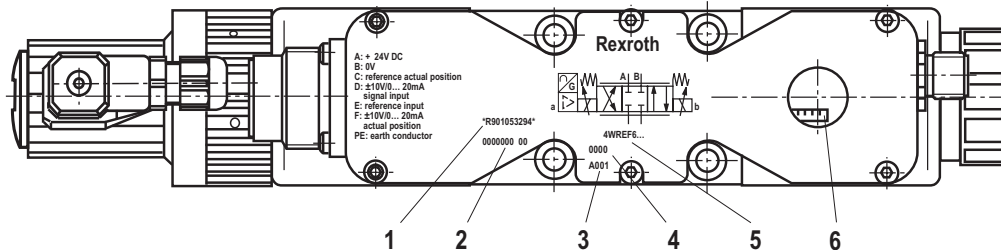

- 1 Material number
- 2 Production order number
- 3 Date of production
- 4 Serial number
- 5 Type designation
- 6 DIL switch for address and baud rate setting
(position B0 on the right)

Electrical connection and allocation

Connector pin assignment X1, 6-pole + PE according to DIN EN 175201-804

Pin	Signal	Interface A1 pin assignment	Interface F1 pin assignment
A	Supply voltage	24 VDC ($u(t) = 19.4$ to 35 V); $I_{max} = 2$ A	
B		0 V	
C	Reference potential actual value	Reference potential actual value	
D	Differential amplifier input	± 10 V command value; $R_e > 50$ k Ω	4 to 20 mA command value; $R_e = 100$ Ω
E		Reference potential command value	
F	Measuring output	± 10 V actual valve control spool value (limit load 5 mA)	4 to 20 mA actual valve control spool value (load resistance maximum 300 Ω)
PE	Protective earthing conductor (directly connected to cooling element and valve housing)		

Connector pin assignment for CAN bus "X2"/"X3" (coding A), M12, 5-pole, pins/socket

Pin	Assignment	Transmission rate kbit/s	20 to 1000
1	n. c.	Bus address	1 to 127
2	n. c.	CAN-specific settings: Baud rate and identifier can be set via the bus system and/or the DIL switches.	
3	CAN_GND		
4	CAN_H		
5	CAN_L		

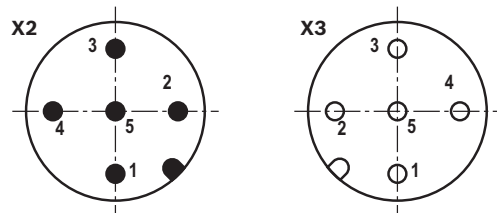

Connector pin assignment for Profibus DP "X2"/"X3" (coding B), M12, 5-pole, socket/pins

Pin	Assignment	Transmission rate Mbaud	up to 12
1	+5 V	Bus address	1 to 126
2	RxD/TxD-N (A line)	Setting via DIL switch. The +5 V voltage of the IFB-P serves to supply an external bus terminator (as required).	
3	D GND		
4	RxD/TxD-P (B line)		
5	Shield		

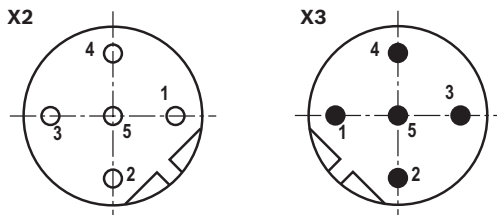

8/22 4WREF | Proportional directional valve with integrated, digital electronics

Integrated electronics (IFB-P), settings for CANopen and Profibus DP

CANopen

B7	B6	B5	B4	B3	B2	B1	B0	HEX	Baud rate: B7, B6	Address range: B5 to B0
0	0	0	0	0	0	0	0	00 ¹⁾	Standard 20 kBaud or re-programmed	1 = Standard or re-programmed
0	0	0	0	0	0	0	1	01		
				to				to		
0	0	1	1	1	1	1	1	3F	20 kBaud	1 to 63
0	1	0	0	0	0	0	0	40	125 kBaud	1 = Standard or re-programmed
0	1	0	0	0	0	0	1	41		
				to				to		
0	1	1	1	1	1	1	1	7F	125 kBaud	1 to 63
1	0	0	0	0	0	0	0	80	250 kBaud	1 = Standard or re-programmed
1	0	0	0	0	0	0	1	81		
				to				to		
1	0	1	1	1	1	1	1	BF	250 kBaud	1 to 63
1	1	0	0	0	0	0	0	C0	500 kBaud	1 = Standard or re-programmed
1	1	0	0	0	0	0	1	C1		
				to				to		
1	1	1	1	1	1	1	0	FE	500 kBaud	1 to 62
1	1	1	1	1	1	1	1	FF	250 kBaud	Monitor mode/programming mode 1 = fixed

Profibus DP

B7	B6	B5	B4	B3	B2	B1	B0	HEX	Address range
0	0	0	0	0	0	0	0	00 ¹⁾	125 = Standard or re-programmed
0	0	0	0	0	0	0	1	01	1 to 126 with parameter channel
				to				to	
0	1	1	1	1	1	1	0	7E	
1	0	0	0	0	0	0	0	80	1 to 126 without parameter channel
				to				to	
1	1	1	1	1	1	1	0	FE	
1	1	1	1	1	1	1	1	FF	Monitor operation address 125

¹⁾ Factory setting

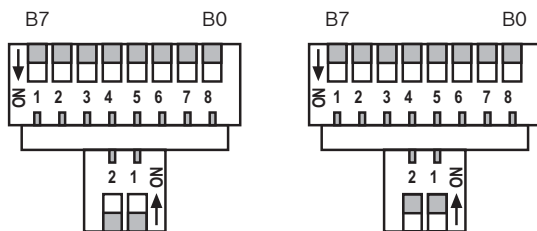

Connection of the bus terminator using the two lower switches (only with Profibus):

Left figure: Bus terminator not connected

Right figure: Bus terminator connected (both switches to "ON")

Integrated electronics (IFB-P), block diagram

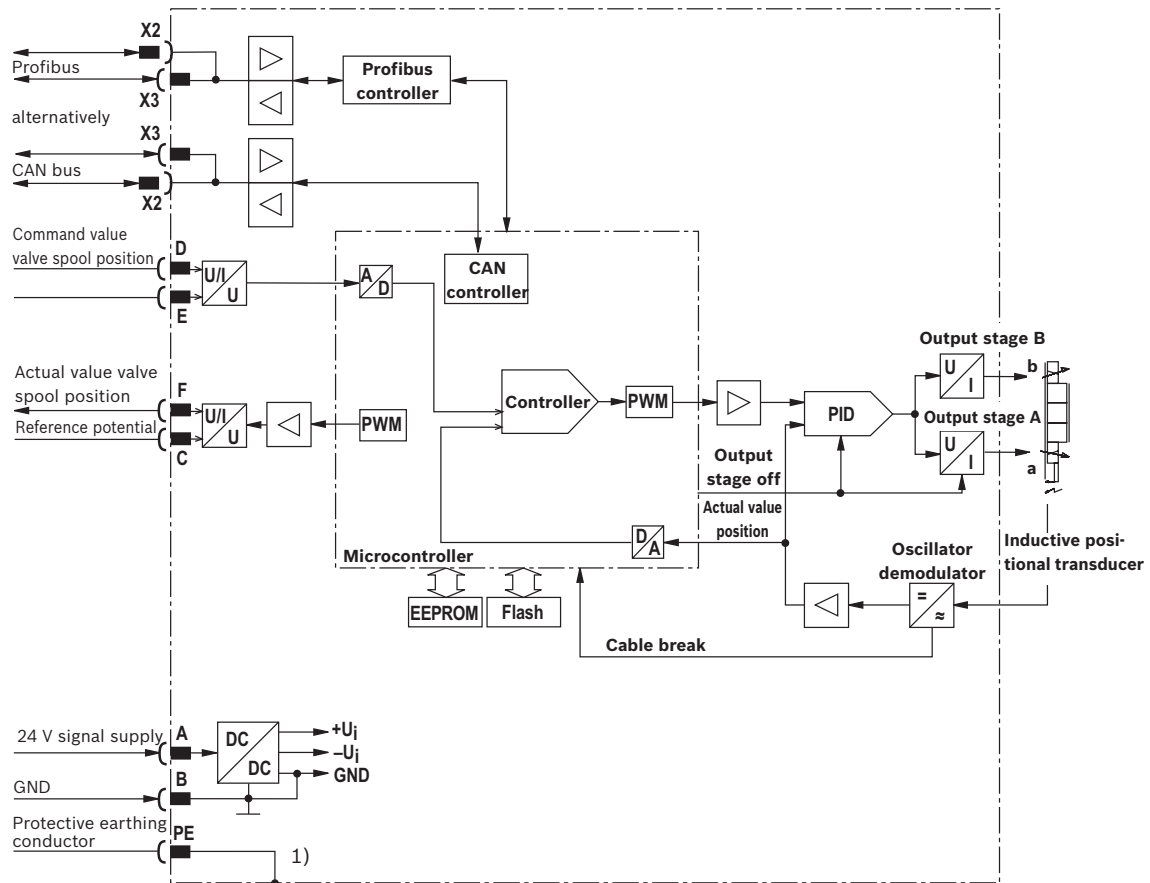

1) The protective earthing conductor (PE) is connected to cooling element and valve housing.

- Command value** Positive command value 0 to +10 V (or 12 to 20 mA) at pin D and reference potential at pin E result in flow from P → A and B → T.
Negative command value 0 to -10 V (or 12 to 4 mA) at pin D and reference potential at pin E result in flow from P → B and A → T.
- Actual value** Positive actual value 0 to +10 V (or 12 to 20 mA) at pin F and reference potential at pin C result in flow from P → A and B → T.
- Connection line** Recommendation:
Up to 25 m line length type LiYCY 7 x 0.75 mm²
Up to 50 m line length type LiYCY 7 x 1.00 mm²
External diameter see sketch of mating connector

10/22 4WREF | Proportional directional valve with integrated, digital electronics

Characteristic curves size 6

(measured with HLP46, $\vartheta_{oil} = 40 \pm 5 \text{ }^\circ\text{C}$ and $p_s = 10 \text{ bar}$)

Transition function with stepped electric input signals (4/3 valve version; V control spool)

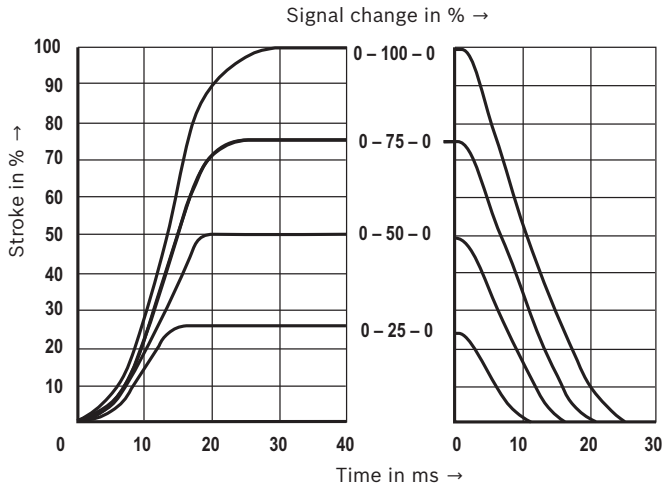

Frequency response (with V control spool)

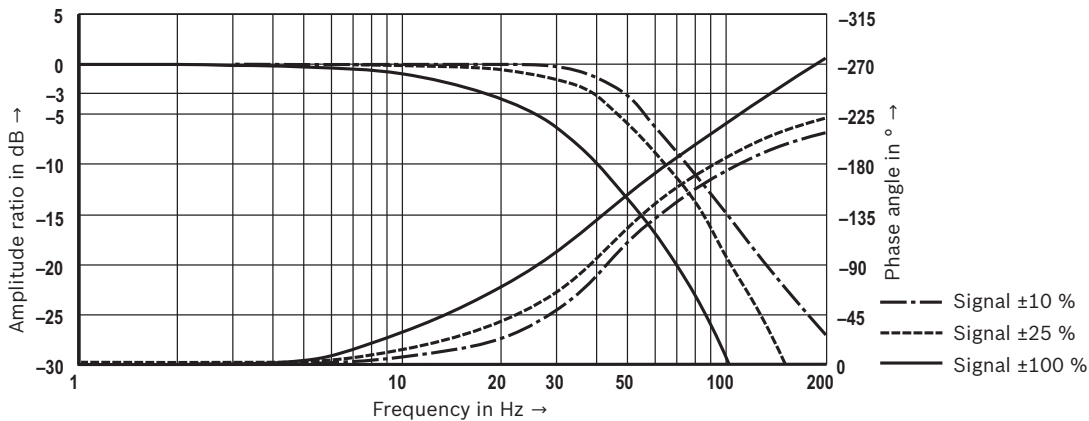

Flow/load function with maximum valve opening (with V control spool)

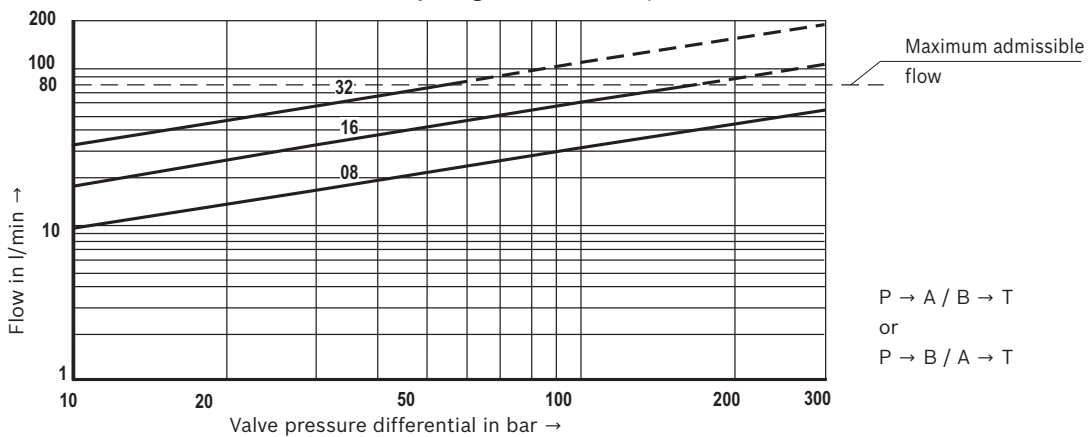

Bosch Rexroth AG, RE 29048, edition: 2014-01

Characteristic curves size 6

(measured with HLP46, $\vartheta_{oil} = 40 \pm 5 \text{ }^\circ\text{C}$ and $p_s = 10 \text{ bar}$)

Pressure/signal characteristic curve (V control spool), $p_s = 100 \text{ bar}$

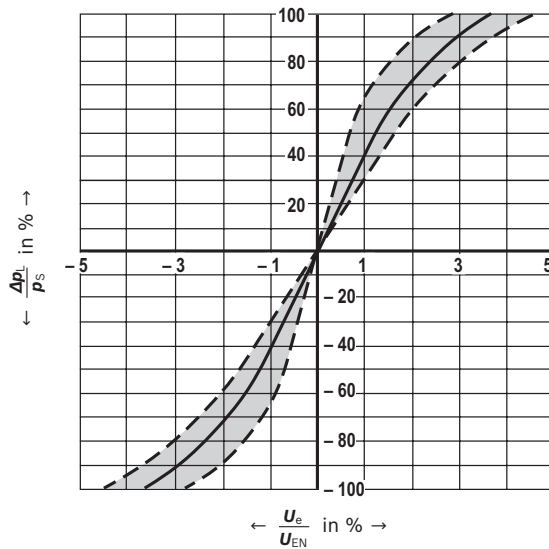

Zero flow (with central control spool position - V control spool)

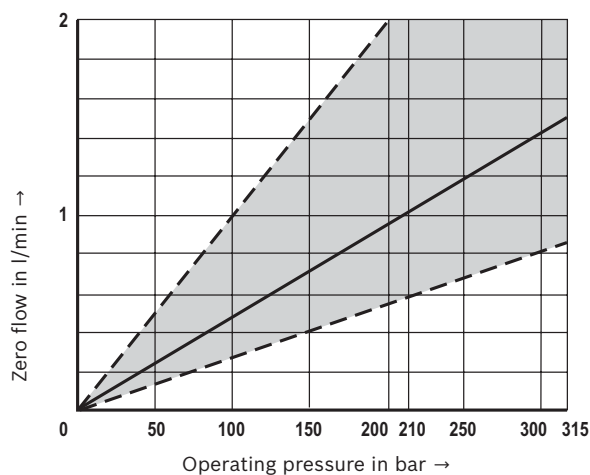

12/22 4WREF | Proportional directional valve with integrated, digital electronics

Characteristic curves size 6

(measured with HLP46, $\vartheta_{oil} = 40 \pm 5 \text{ }^\circ\text{C}$ and $p = 100 \text{ bar}$)

8 l/min rated flow

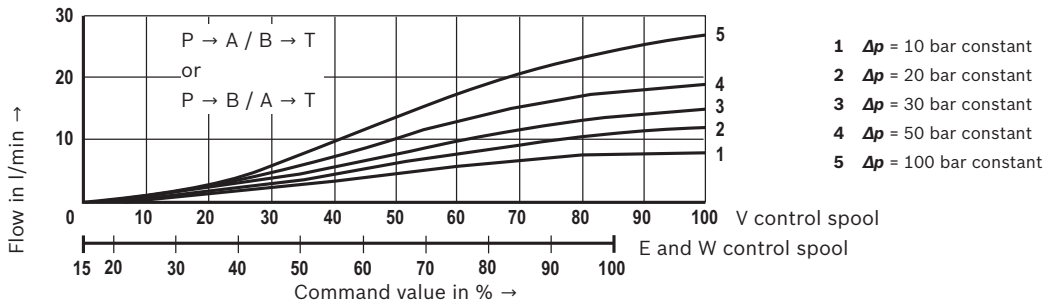

16 l/min rated flow

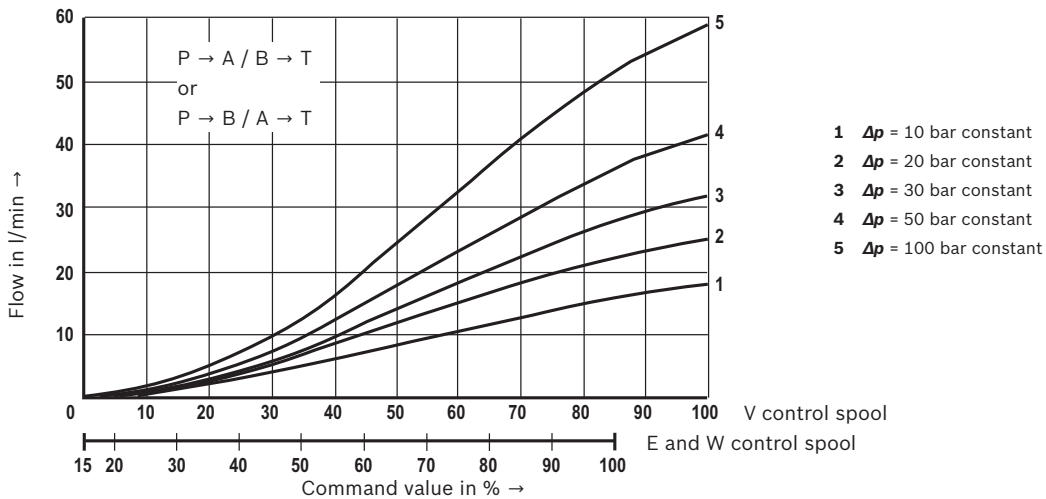

32 l/min rated flow

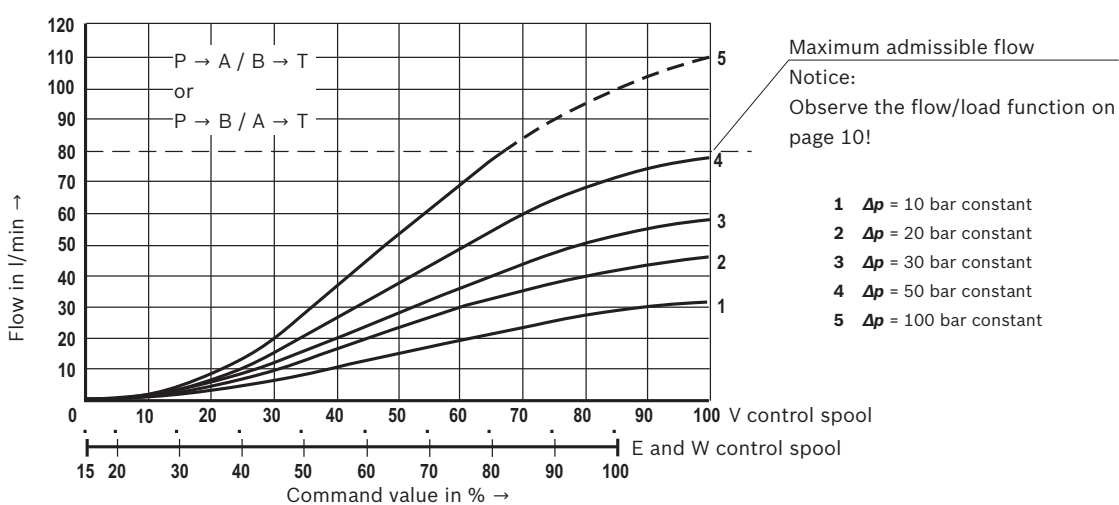

Bosch Rexroth AG, RE 29048, edition: 2014-01

Characteristic curves size 10

(measured with HLP46, $\vartheta_{oil} = 40 \pm 5 \text{ }^\circ\text{C}$ and $p_s = 10 \text{ bar}$)

Transition function with stepped electric input signals (4/3 valve version; V control spool)

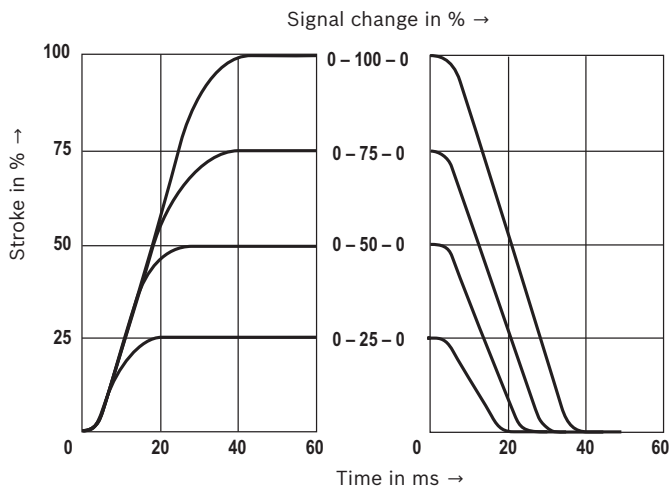

Flow/load function with maximum valve opening (with V control spool)

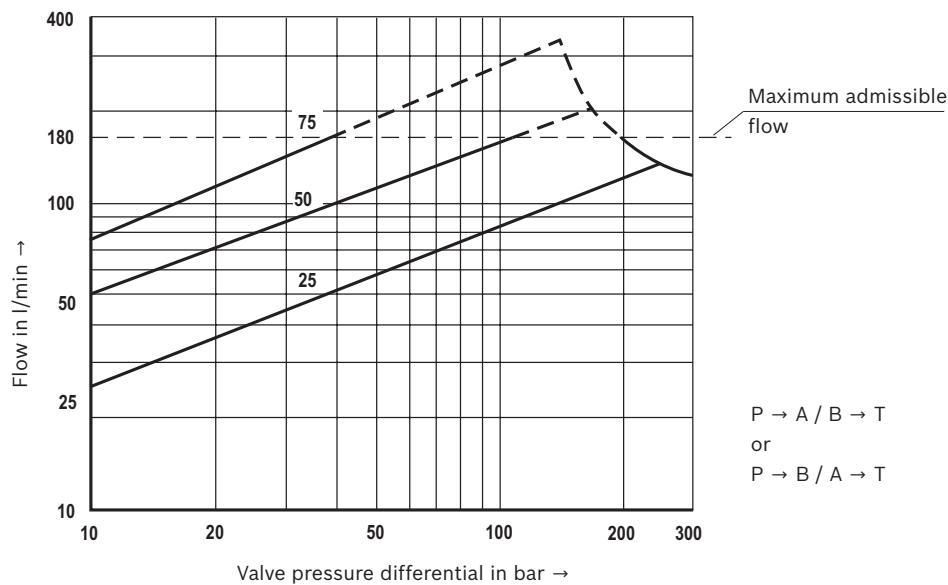

14/22 **4WREF** | Proportional directional valve with integrated, digital electronics

Characteristic curves size 10

(measured with HLP46, $\vartheta_{oil} = 40 \pm 5 \text{ }^\circ\text{C}$ and $p_s = 10 \text{ bar}$)

Frequency response (with V control spool)

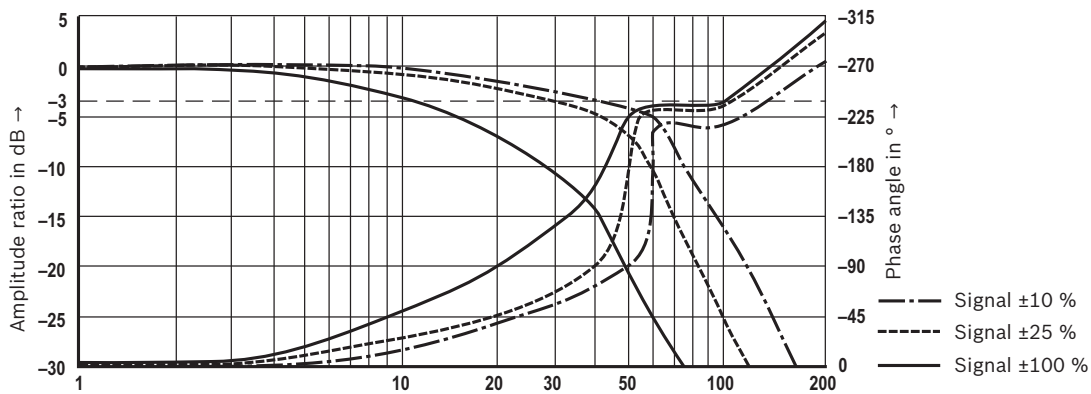

Pressure/signal characteristic curve (V control spool), $p_s = 100 \text{ bar}$

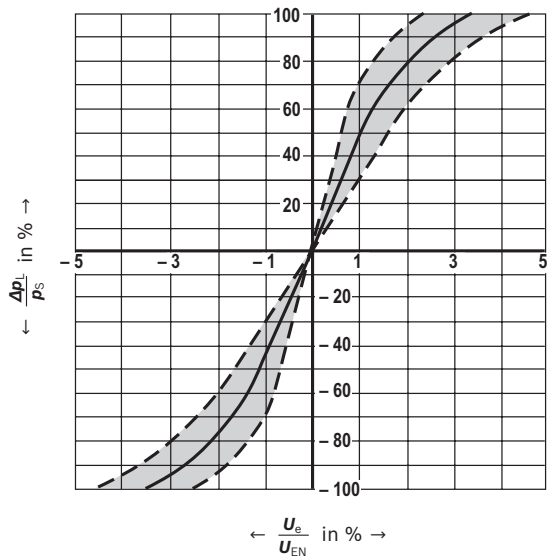

Zero flow (with central control spool position - V control spool)

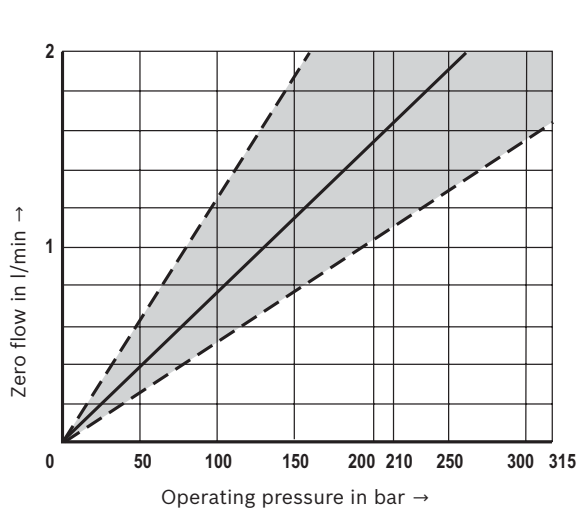

Bosch Rexroth AG, RE 29048, edition: 2014-01

Proportional directional valve with integrated, digital electronics | **4WREF** 15/22

Characteristic curves size 10

(measured with HLP46, $\vartheta_{oil} = 40 \pm 5 \text{ }^\circ\text{C}$ and $p = 100 \text{ bar}$)

25 l/min rated flow

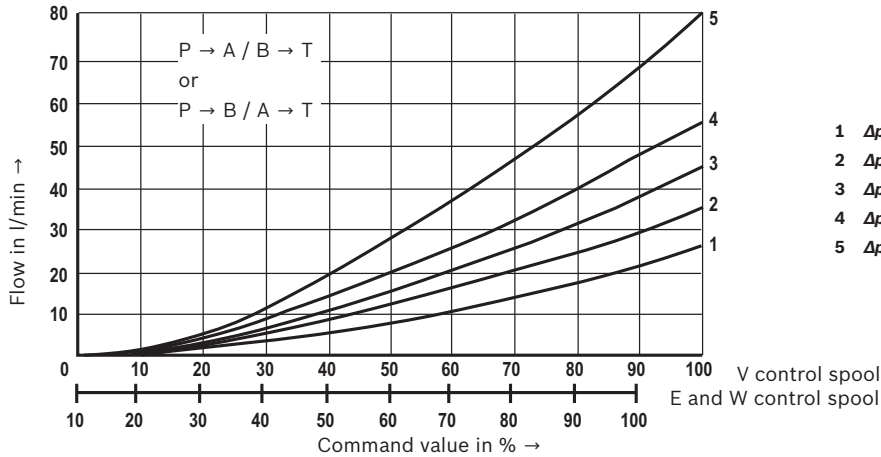

- 1 $\Delta p = 10 \text{ bar constant}$
- 2 $\Delta p = 20 \text{ bar constant}$
- 3 $\Delta p = 30 \text{ bar constant}$
- 4 $\Delta p = 50 \text{ bar constant}$
- 5 $\Delta p = 100 \text{ bar constant}$

50 l/min rated flow

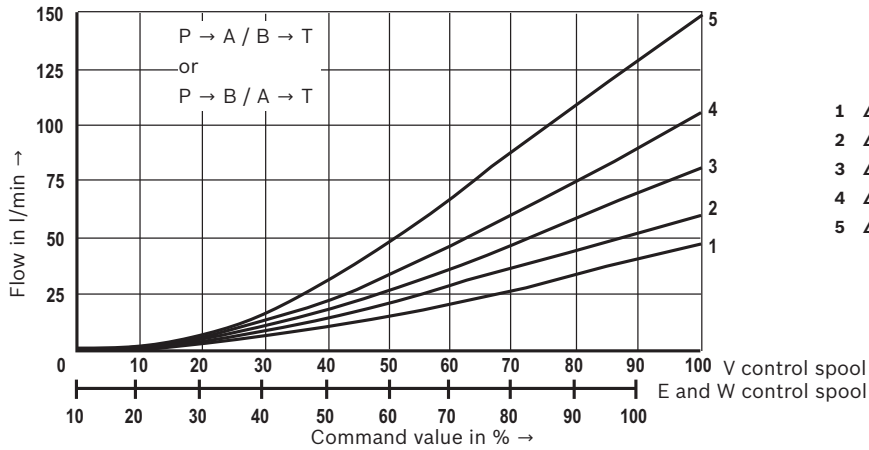

- 1 $\Delta p = 10 \text{ bar constant}$
- 2 $\Delta p = 20 \text{ bar constant}$
- 3 $\Delta p = 30 \text{ bar constant}$
- 4 $\Delta p = 50 \text{ bar constant}$
- 5 $\Delta p = 100 \text{ bar constant}$

75 l/min rated flow

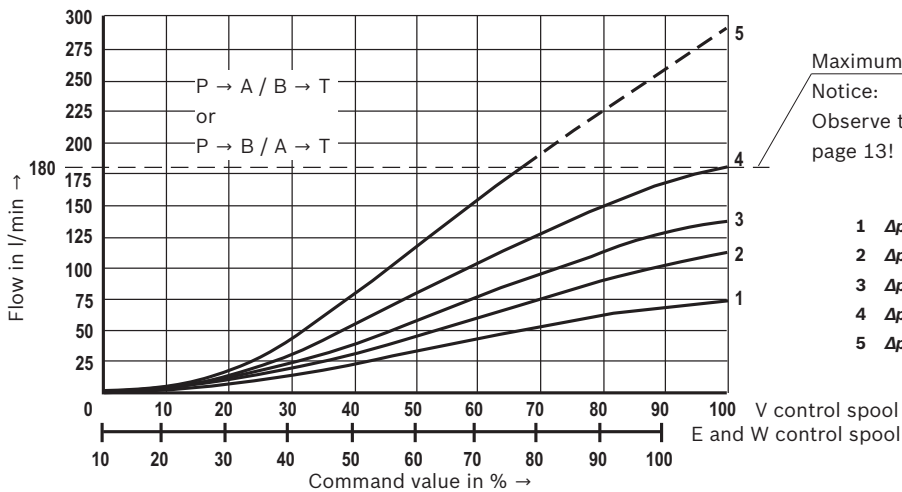

Maximum admissible flow
Notice:
Observe the flow/load function on page 13!

- 1 $\Delta p = 10 \text{ bar constant}$
- 2 $\Delta p = 20 \text{ bar constant}$
- 3 $\Delta p = 30 \text{ bar constant}$
- 4 $\Delta p = 50 \text{ bar constant}$
- 5 $\Delta p = 100 \text{ bar constant}$

RE 29048, edition: 2014-01, **Bosch Rexroth AG**

16/22 4WREF | Proportional directional valve with integrated, digital electronics

Dimensions for size 6:
(dimensions in mm)

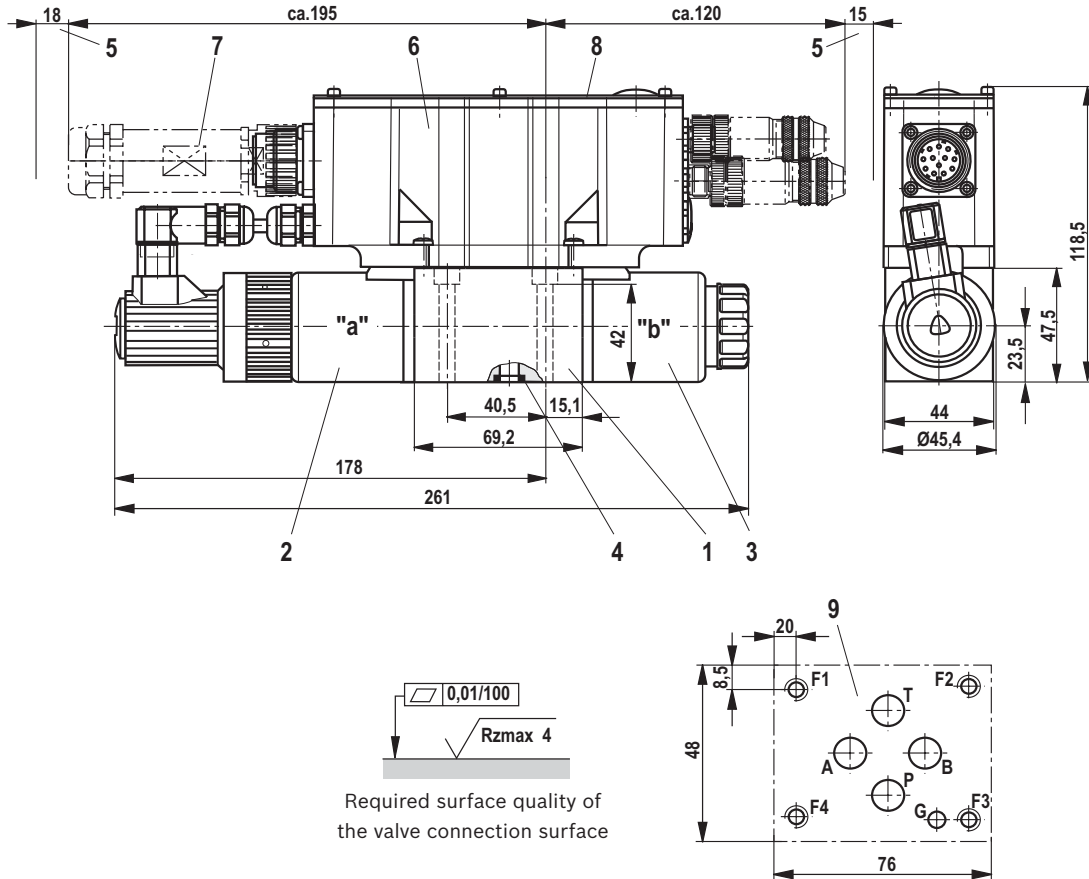

- 1 Valve housing
- 2 Proportional solenoid "a" with inductive position transducer
- 3 Proportional solenoid "b"
- 4 R-ring 9.81 x 1.5 x 1.78 for ports P, T, A and B
- 5 Space required to remove the mating connectors
- 6 Integrated digital control electronics
- 7 Mating connector according to DIN EN 175201-804; separate order, see page 19
- 8 Name plate
- 9 Machined valve contact surface, porting pattern according to ISO 4401-03-02-0-05
Deviating from the standard:
Ports P, A, B, T Ø8 mm
Bore G may not be required since there is no pin in the valve.

Notice!

The dimensions are nominal dimensions and subject to tolerances.

For valve mounting screws and subplates, see page 18.

Proportional directional valve with integrated, digital electronics | **4WREF** 17/22

Dimensions for size 10:
(dimensions in mm)

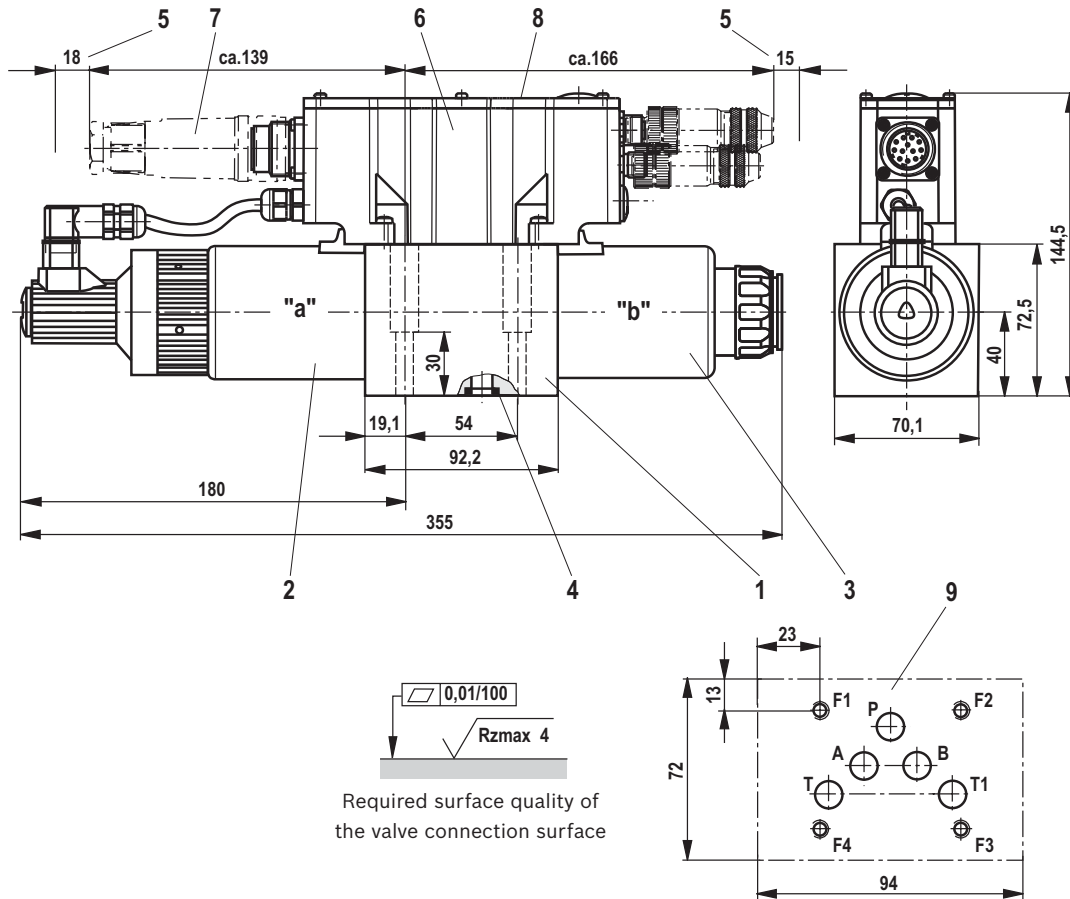

- 1 Valve housing
- 2 Proportional solenoid "a" with inductive position transducer
- 3 Proportional solenoid "b"
- 4 R-ring 13.0 x 1.6 x 2.0 for ports P, T, T1, A and B
- 5 Space required to remove the mating connectors
- 6 Integrated digital control electronics
- 7 Mating connector according to DIN EN 175201-804; separate order, see page 19
- 8 Name plate
- 9 Machined valve contact surface, porting pattern according to ISO 4401-05-04-0-05

Notice!

The dimensions are nominal dimensions and subject to tolerances.

For valve mounting screws and subplates, see page 18.

RE 29048, edition: 2014-01, **Bosch Rexroth AG**

18/22 **4WREF** | Proportional directional valve with integrated, digital electronics

Dimensions

Hexagon socket head cap screws		Material number
Size 6	4x ISO 4762 - M5 x 50 - 10.9-flZn-240h-L Tightening torque $M_A = 7 \text{ Nm} \pm 10 \%$ or 4x ISO 4762 - M5 x 50 - 10.9 Tightening torque $M_A = 8.9 \text{ Nm} \pm 10 \%$	R913000064
Size 10	4x ISO 4762 - M6 x 40 - 10.9-flZn-240h-L Tightening torque $M_A = 12.5 \text{ Nm} \pm 10 \%$ or 4x ISO 4762 - M6x 40 - 10.9 Tightening torque $M_A = 15.5 \text{ Nm} \pm 10 \%$	R913000058

Notice: The tightening torque of the hexagon socket head cap screws refers to the maximum operating pressure!

Subplates	Data sheet
Size 6	45052
Size 10	45054

Accessories (not included in the scope of delivery)

	The following is required for the parameterization via PC:	CANopen	Profibus DP
1	Interface converter (USB)	VT-ZKO-USB/CA-1-1X/V0/0 Mat. no. R901071963	VT-ZKO-USB/P-1-1X/V0/0 Mat. no. R901071962
2	Commissioning software	WIN-PED 6 Download from www.boschrexroth.de/IAC	
3	Connection cable, 3 m	D-Sub / M12, coding A Mat. no. R900751271	D-Sub / M12, coding B Mat. no. R901078053

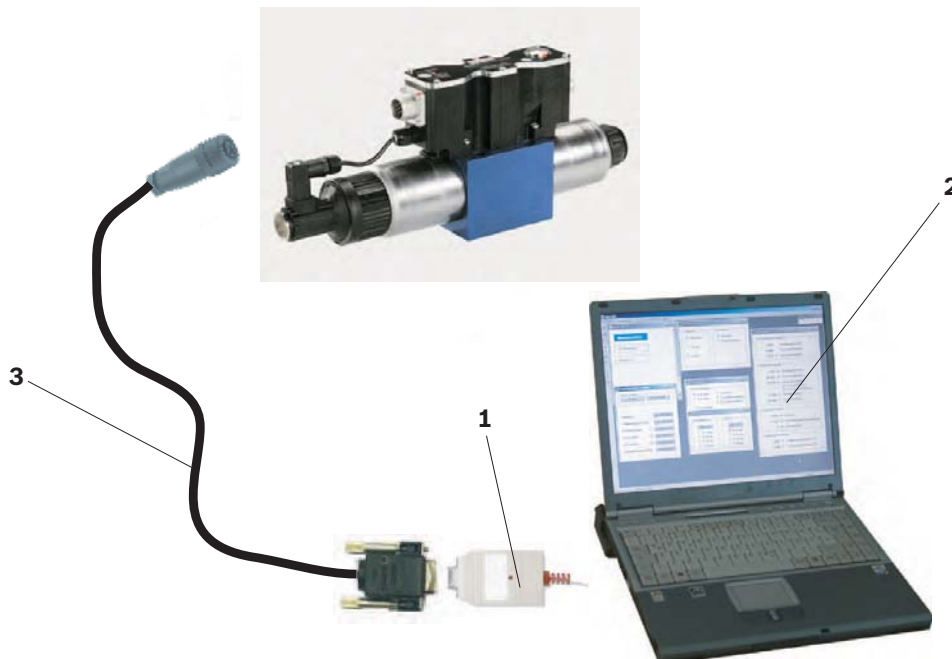

Bosch Rexroth AG, RE 29048, edition: 2014-01

Proportional directional valve with integrated, digital electronics | **4WREF** 19/22

Accessories, port X1 (not included in the scope of delivery)

Mating connector for X1	Version	Material number
Mating connector according to DIN EN 175201-804 (6-pole)	Mating connector (plastic)	R900021267
	Mating connector (angular design)	R900217845

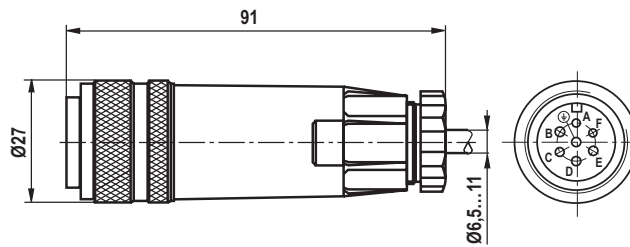

Mating connector for X1	Version	Material number
Mating connector according to DIN EN 175201-804 (6-pole)	Mating connector (metal)	R900223890

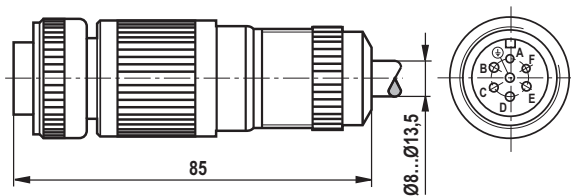

RE 29048, edition: 2014-01, **Bosch Rexroth AG**

20/22 **4WREF** | Proportional directional valve with integrated, digital electronics

Accessories, CAN bus (A coding) (not included in the scope of delivery)

Description	View, dimensions	Pole pattern, order details
X2 Round connector, 5-pole, M12, can be assembled Straight mating connector in metal design		<p>Mat. no. R901076910 (cable diameter 6 to 8 mm)</p>
X3 Round connector, 5-pole, M12, can be assembled Straight line connector in metal design		<p>Mat. no. R901076906 (cable diameter 6 to 8 mm)</p>
M12 cap Dust protection (only for pins)		<p>Mat. no. R901075564</p>

Accessories, Profibus (B coding) (not included in the scope of delivery)

Description	View, dimensions	Pole pattern, order details
X2 Round connector, 5-pole, M12, can be assembled Straight line connector in metal design		<p>Mat. no. R901075545 (cable diameter 6 to 8 mm)</p>
X3 Round connector, 5-pole, M12, can be assembled Straight mating connector in metal design		<p>Mat. no. R901075550 (cable diameter 6 to 8 mm)</p>
M12 protective cap (only for socket)		<p>Mat. no. R901075563</p>

Bosch Rexroth AG, RE 29048, edition: 2014-01

Project planning/maintenance instructions/additional information

Product documentation for IFB-P

- ▶ Data sheet 29048 (this data sheet)
- ▶ Operating manual 29015-B
- ▶ CAN bus protocol description data sheet 29015-01-Z
- ▶ Profibus protocol description data sheet 29015-02-Z
- ▶ General information on the maintenance and commissioning of hydraulic components 07800/07900
- ▶ General operating instructions: Hydraulic valves for industrial applications 07600-B

Commissioning software and documentation on the internet: www.boschrexroth.com/IAC

Maintenance instructions:

- ▶ The devices have been tested in the plant and are supplied with default settings.
- ▶ Only complete units can be repaired. Repaired devices are returned with default settings. User-specific settings will not be applied. The machine end-user will have to retransfer the corresponding user parameters.

Notices:

- ▶ Connect the valve to the supply voltage only when this is required for the functional processes of the machine.
- ▶ Do not use electrical signals provided via control electronics (e.g. "No error" signal) for switching safety-relevant machine functions (see also EN ISO 13849 "Safety of machinery – safety-related parts of control systems").
- ▶ If electro-magnetic interference is to be anticipated, suitable measures must be taken to ensure the function (depending on the application, e.g. shielding, filtration)!
- ▶ For more information, refer to the operating instructions and the WIN-PED online help.

22/22 **4WREF** | Proportional directional valve with integrated, digital electronics

© This document, as well as the data, specifications and other information set forth in it, are the exclusive property of Bosch Rexroth AG. It may not be reproduced or given to third parties without its consent.
The data specified above only serve to describe the product. No statements concerning a certain condition or suitability for a certain application can be derived from our information. The information given does not release the user from the obligation of own judgment and verification. It must be remembered that our products are subject to a natural process of wear and aging.

Bosch Rexroth AG, RE 29048, version: 2014-01