



Workholding Systems

HILMA EL/NC

1.3020

1.3070

1.3080

02/2016

Products for productivity



ROEMHELD
HILMA ■ STARK

HILMA EL/NC

EL machine vice

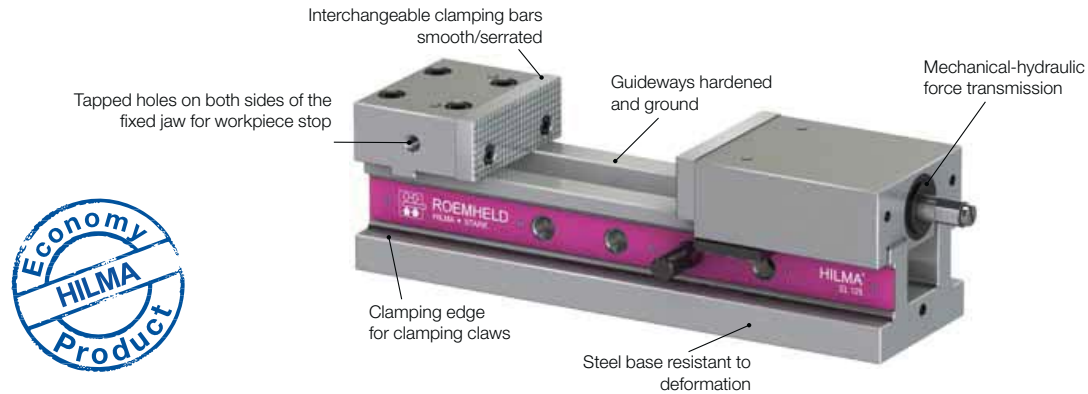

NC machine vice

Version: mechanical-hydraulic

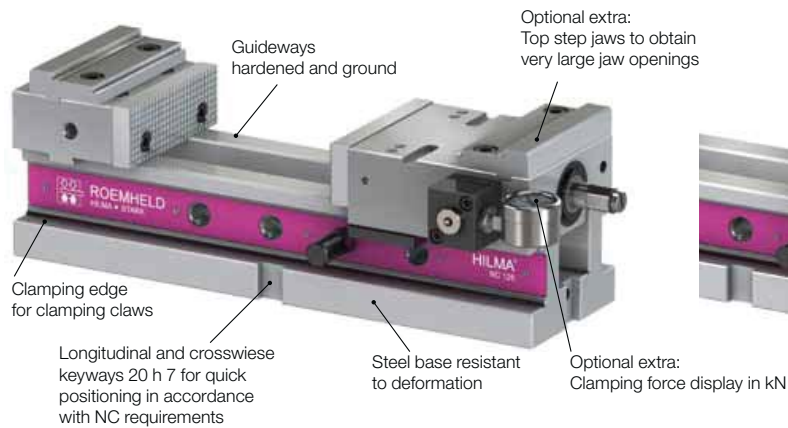

NC machine vice

Version: hydraulic

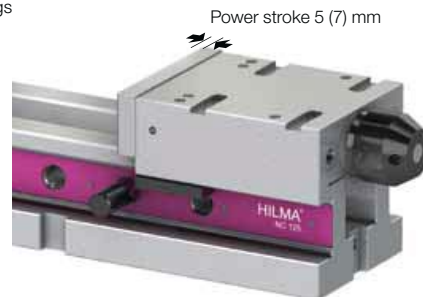

Your benefits at a glance:

- ★ High flexibility
- ★ Control of the clamping force by means of a pressure gauge for NC (optional extra)
- ★ Simple and quick cleaning
- ★ Quick retrofitting
- ★ Quick adjustment of the clamping range by socket pins



EL machine vice
mechanical-hydraulic



NC machine vice
mechanical-hydraulic
with clamping force display and top jaws



NC machine vice
hydraulic



When using for example floating central jaws or top jaws (NC), several small components as well as large-volume workpieces can be clamped.

The high-precision reproducibility of the clamping forces guarantees a maximum possible repetitive accuracy of the clamping processes and thus increases the clamping quality. The generated clamping force can be visually checked at any time.

The removal of the slide facilitates a simple and quick cleaning of the clamping system. Thus cost intensive downtimes will be reduced.

Minimum set-up times ensure versatile use and thus considerable cost reduction.

Thanks to the quick adjustment by socket pins proven for decades, a quick adaptation to very different clamping ranges is possible with minimum effort on the crank handle.



ROEMHELD
HILMA ■ STARK

Technical Data HILMA EL/NC mechanical-hydraulic

EL machine vice mechanical-hydraulic for tool making, mould making, construction of jigs and fixtures and production

The mechanical-hydraulic force transmission requires minimum effort on the crank handle. An angle drive (optional extra), that can also be retrofitted, facilitates the operation, e.g. in the case of longitudinal clamping on the machine table. The optional clamping force preselection (retrofitable) enables the force to be applied in 6 stages up to the maximum.

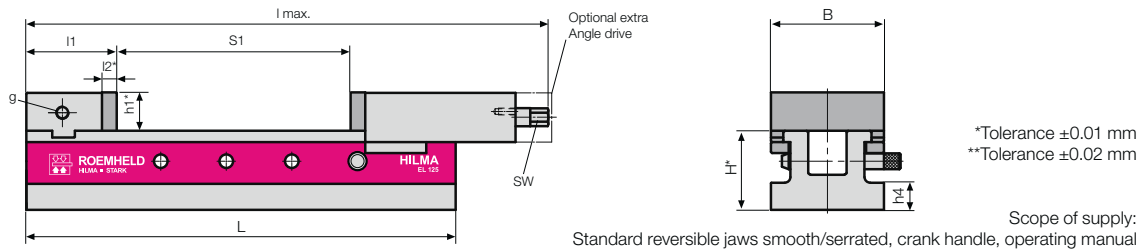

Type	Part no.	Clamping force [kN]	Weight [kg]	Dimensions mm											
				L	B	H	g	h1	h4	l max	l1	l2	Jaw opening S1	SW	
EL100	9.3022.1113	25	18,5	380	100	70	M12 x 18	34	24	24	464	80	13	205	14
EL125	9.3023.1113	40	31,5	430	125	82	M12 x 18	45	27	27	526	100	15	225	17
EL160	9.3024.1113	50	58,5	550	160	95	M20 x 27	54	27	27	684	120	18	309	19
EL160L	9.3024.1313 with angle drive	50	75,0	750	160	95	M20 x 27	54	27	27	884	120	18	509	19

NC machine vice mechanical-hydraulic for tool making, mould making, construction of jigs and fixtures and production

The mechanical-hydraulic force transmission requires minimum effort on the crank handle. An angle drive (optional extra), that can also be retrofitted, facilitates the operation, e.g. in the case of longitudinal clamping on the machine table. The version with clamping force display allows a continuous and precise clamping force transmission. This offers enormous advantages, inter alia, in roughing and finishing operations as well as for the reproducibility of clamping forces. In addition, the clamping force display ensures adequate safety by the permanent clamping and system control.

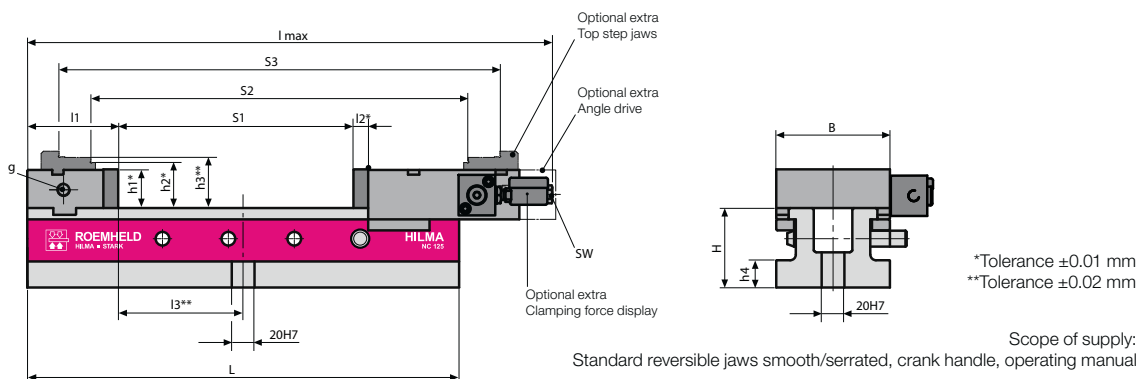

Type	Part no.	Part no. with clamping force display	Clamping force [kN]	Weight [kg]	Dimensions mm															
					L	B	H	g	h1	h2	h3	h4	l max	l1	l2	l3	Jaw opening S1	S2	S3	SW
NC100	9.3072.0203	9.3072.0213	25	18,5	380	100	70	M12 x 18	34	40	45	24	464	80	13	110	205	330	386	14
NC125	9.3073.0203	9.3073.0213	40	31,5	430	125	82	M12 x 18	45	53	58	27	526	100	15	115	225	363	431	17
NC160	9.3074.0203	9.3074.0213	50	58,5	550	160	95	M20 x 27	54	65	70	27	684	120	18	155	309	503	573	19

Jaws and accessories see page 6 to 10

Technical Data HILMA NC hydraulic



ROEMHELD
HILMA ■ STARK

NC machine vice hydraulic for use in semi or fully-automatic operation in series production

Connection to a separate hydraulic pressure transducer, e.g. a hydraulic power unit. Coarse adjustment of the clamping range using socket pins. Precise positioning against the workpiece and adjustment of the insertion tolerance manually using a lead screw. The clamping process is triggered by a hand or foot switch or, in the case of fully automatic working cycle, by and electrical control pulse.

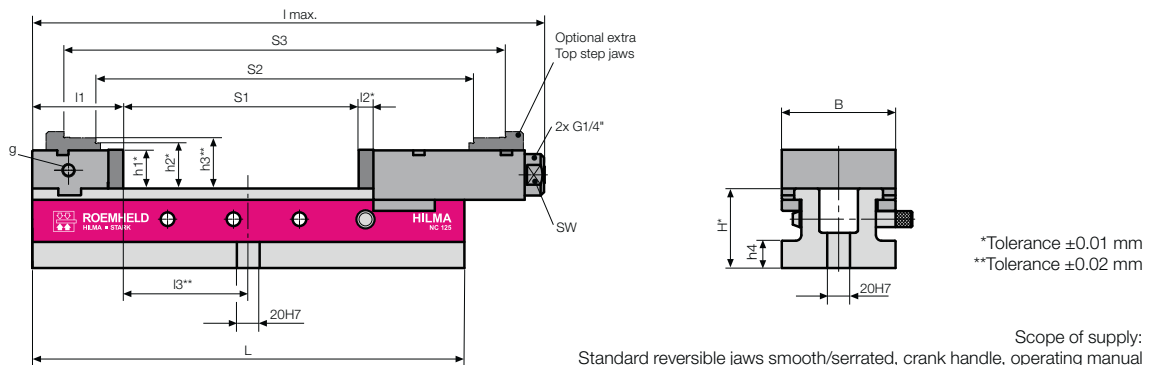

Type	Part no.	Clamp- ing force [kN]	Operating pressure [bar]	Stroke	Weight [kg]	Dimensions mm													Clamping width			
						L	B	H	g	h1	h2	h3	h4	l max	l1	l2	l3	S1	S2	S3	SW	
NC100	9.3082.0203	25	350	5	18,5	380	100	70	M12 x 18	34	40	45	24	456	80	13	110	209	334	390	8	
NC125	9.3083.0203	40	350	5	31,5	430	125	82	M12 x 18	45	53	58	27	518	100	15	115	228	366	434	8	
NC160	9.3084.0203	63	350	7	58,5	550	160	95	M20 x 27	54	65	70	27	675	120	18	155	314	508	578	10	

Jaws and accessories see page 6 to 10

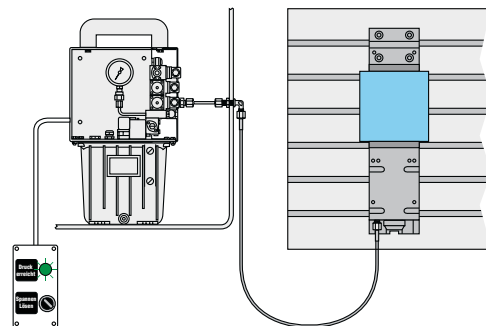

Examples for hydraulic power units

Part no.	Flow rate [l/min]	Operating pressure [bar]	Number of valves (clamping circuits)	Pressure monitoring	Remote control (manual switch)	Variants of application
6810-565	0.82	350	–	yes	–	without valves, operation by valve(s) with turning knob
6810-566	0.82	350	1	yes	1	1-circuit version (standard)
6810-567	0.82	350	2	yes	2	2-circuit version (alternating operation)



ROEMHELD
HILMA ■ STARK

HILMA standard clamping jaws

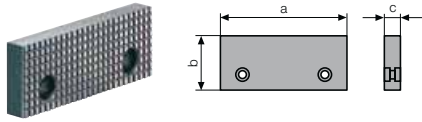

Standard jaw smooth/serrated

Part no.	a	b	c
5.2058.1003	100	34	13
5.2058.1004	125	45	15
5.2058.1005	160	54	18

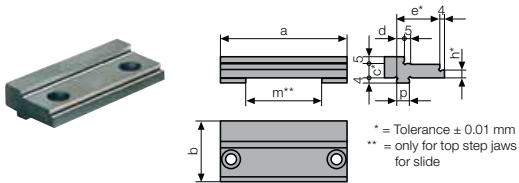

Top step jaw

for fixed jaw Part no.	for slide Part no.	a	c	d	e	h	l	m	p
9.3284.0201	9.3284.1201	100	11,5	6	34	6,5	48	60	10h6
9.3284.0301	9.3284.1301	125	14,0	6	40	9,0	58	65	12h6
9.3284.0401	9.3284.1401	160	17,0	8	43	12,0	64	88	18h6

* = Tolerance ± 0.01 mm
** = only for top step jaws for slide

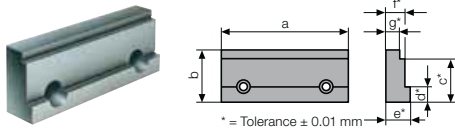

Precision step jaw

Part no.	a	b	c	d	e	f	g
5.2082.0001	100	34	29	10	19	15	11
5.2082.0002	125	45	39	13	25	20	16
5.2082.0003	160	54	45	15	25	20	16

* = Tolerance ± 0.01 mm

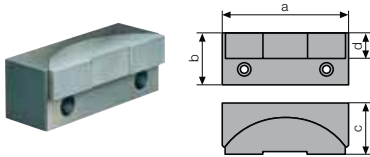

Pendulum jaw

Part no.	a	b	c	d
8.3711.0208	100	34	35	16
8.3711.0308	125	45	50	22
8.3711.0408	160	54	55	26

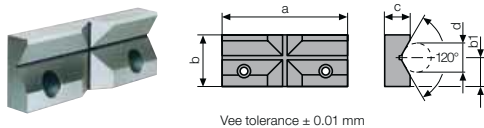

Vee jaw

Part no.	a	b	b1	c	d
5.3030.0002	100	34	19	17	8 – 35
5.3030.0003	125	45	27	19	10 – 50
5.3030.0004	160	54	32	21	12 – 60

Vee tolerance ± 0.01 mm

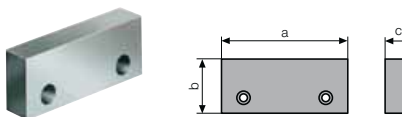

Clamping jaw, soft

Part no.	a	b	c
5.2055.0097	100	36	20
5.2055.0098	125	47	25
5.2055.0099	160	56	30

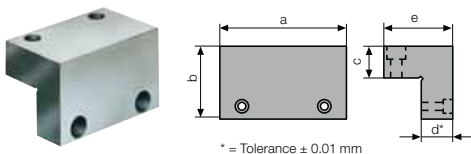

Clamping jaw, extra high

Part no.	a	b	c	d	e
9.3283.0201	100	58,0	25	25	60
9.3283.0301	125	75,5	32	32	74
9.3283.0401	160	92,5	40	40	100

* = Tolerance ± 0.01 mm

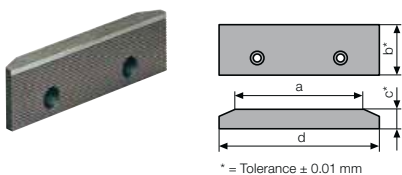

Clamping jaw extra large

Part no.	a	b	c	d
5.2058.1025	100	34	13	125
5.2058.1026	125	45	15	160
5.2058.1027	160	54	20	200

* = Tolerance ± 0.01 mm

all dimensions in mm

HILMA QIS jaws



ROEMHELD
HILMA ■ STARK

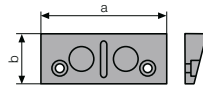

QIS base jaw with permanent magnets

Part no.	a	b
9.3771.0201	100	34
9.3771.0301	125	45
9.3771.0401	160	54

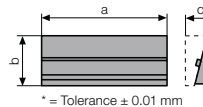

QIS interchangeable jaw, smooth

Part no.	a	b	c
8.3771.1201	100	34	21
8.3771.1301	125	45	26
8.3771.1401	160	54	31

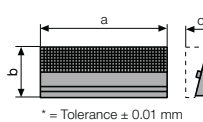

QIS interchangeable jaw, serrated

Part no.	a	b	c
8.3771.2201	100	34	21
8.3771.2301	125	45	26
8.3771.2401	160	54	31

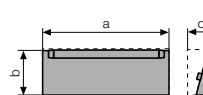

QIS interchangeable jaw, crowned

Part no.	a	b	c
8.3771.3211	100	32,5	23,0
8.3771.3311	125	43,0	27,3
8.3771.3411	160	51,0	31,9

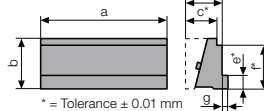

QIS interchangeable jaw, stepped

Part no.	a	b	c	d	e	f	g
8.3771.4201	100	34	21	25	10	29	4
8.3771.4301	125	45	26	30	13	39	5
8.3771.4401	160	54	31	35	15	45	5

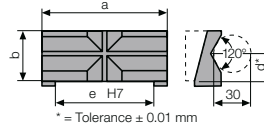

QIS interchangeable jaw, prismatic

Part no.	Ø up to	a	b	c	d	e	f
8.3771.5201	8 – 35	100	34	53	19	78	28,0
8.3771.5301	10 – 50	125	45	58	27	98	34,2
8.3771.5401	12 – 60	160	54	60	32	125	37,0

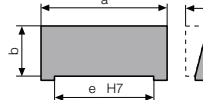

QIS interchangeable jaw, soft

Part no.	a	b	c	e
8.3771.7201	100	34	30,0	78
8.3771.7301	125	45	36,5	98
8.3771.7401	160	54	47,0	125

all dimensions in mm

Mount magnetic base jaw



Parallel approach of the QIS jaw and insertion guided by a locating pin



Jaw change in a few seconds:

Push up the QIS jaw to the end of the slot and tilt

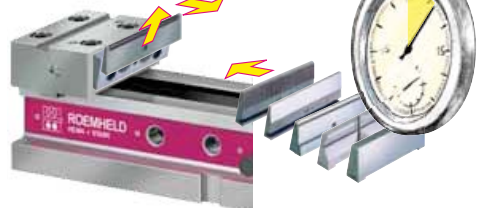



ROEMHELD
HILMA ■ STARK

HILMA SlimFlex and SMV jaws

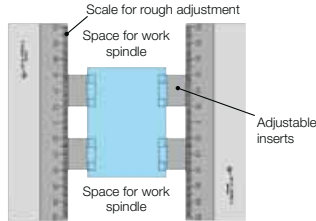

SlimFlex jaw system, standard version

Jaw width	Part no. Interchangeable jaw without step inserts	Part no. Interchangeable jaw with step inserts	Part no. Insert C45 soft
100	9.3714.0202	9.3714.0212	5.5050.0123
125	9.3714.0302	9.3714.0312	5.5050.0099
160	9.3714.0402	9.3714.0412	5.5050.0099

Jaw width	Dimensions in mm								
	b	c1	c2	e	h1	h2	l	m	n
100	34	30	33	10	24	31	78	11	30
125	45	32	35	15	30	42	98	16	40
160	54	34	37	15	39	51	125	16	40

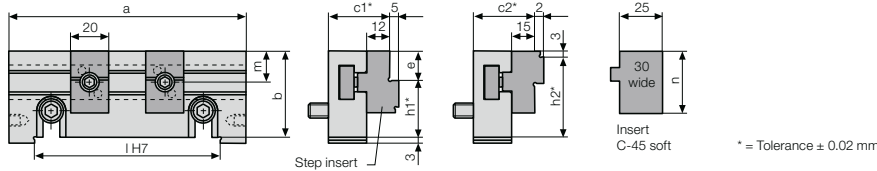

Slim Flex jaw system, QIS version

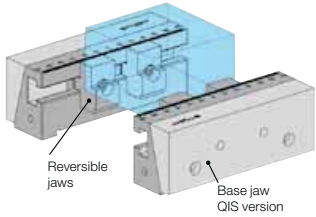

Jaw width	Part no. Interchangeable jaw without step inserts	Part no. Interchangeable jaw with step inserts	Part no. Insert C45 soft	Part no. QIS base jaw
100	9.3771.9201	9.3771.9211	5.5050.0123	9.3771.0201
125	9.3771.9301	9.3771.9311	5.5050.0099	9.3771.0301
160	9.3771.9401	9.3771.9411	5.5050.0099	9.3771.0401

Jaw width	Dimensions in mm								
	a	b	c3	c4	e	h1	h2	l	m
100	34	45	48	10	24	31	78	11	30
125	45	50	53	15	30	42	98	16	40
160	54	55	58	15	39	51	125	16	40

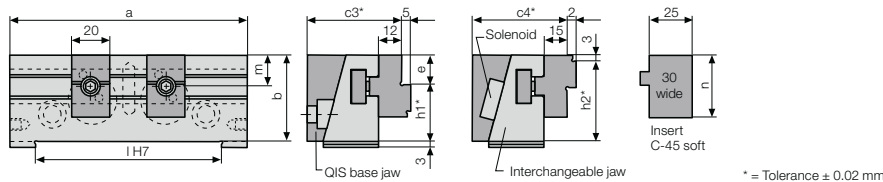

Floating central jaw, standard version

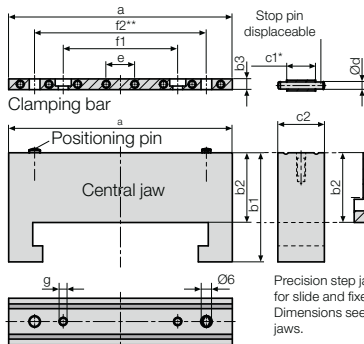

Jaw width	Part no. Central jaw with clamping bar	Part no. Clamping bar	Part no. Precision step bar	Dimensions in mm											
				b1	b2	b3	c1	c2	Ød	e	f1	f2	g		
100	9.3715.0211	9.3715.1201	5.2082.0001	48	29	5	12	20	3	13	52	78	M5		
125	9.3715.0311	9.3715.1301	5.2082.0002	61	39	6	16	26	4	16	64	96	M5		
160	9.3715.0411	9.3715.1401	5.2082.0003	70	45	9	20	30	5	20	80	120	M6		



* = Tolerance -0.01 mm
** = Tolerance ± 0.02 mm

Efficient and economic:
Existing or new HILMA machine vices can be retrofitted from single to multiple clamping systems at low costs and with minimum retrofitting work.

HILMA clamping jaws and jaw inserts with grip

to increase the retention force
for NC machine vices **with clamping pressure display**



ROEMHELD
HILMA ■ STARK

Using clamping jaws or jaw inserts with coating or grip toothing, the retention forces for safe clamping of workpieces can be considerably increased. Only machine vices with clamping force display allow the controlled use of these clamping jaws/inserts.

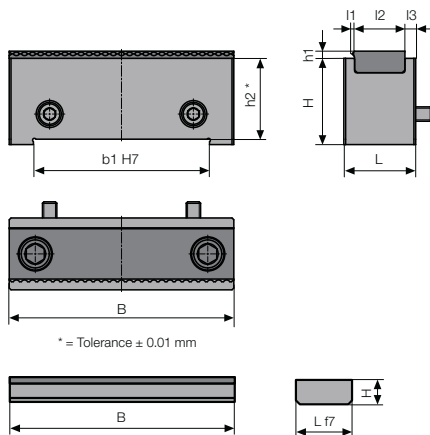
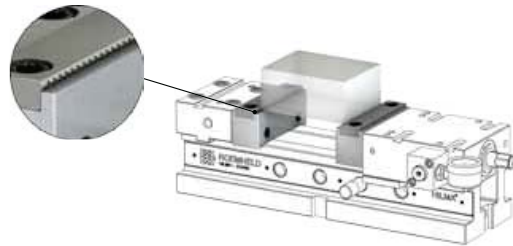

Clamping bar with jaw insert, grip

Part no.	L	B	H	i1	i2	i3	b1	h1	h2
9.3286.0201	34	100	37	1,5	22	6	78	4	34
9.3286.0301	40	125	48	1,5	28	6	98	4	45
9.3286.0401	46	160	57	1,5	34	6	125	6	54

Jaw insert for clamping bar, HM coated

Part no.	L	B	H						
5.5050.0692	22	100	10						
5.5050.0694	28	125	12						
5.5050.0696	34	160	16						

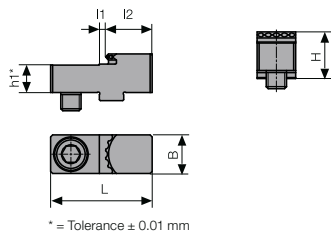
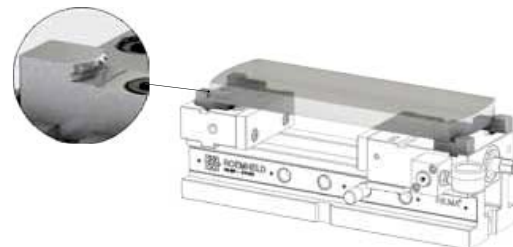

Jaw insert for fixed jaw and slide, grip

Part no.	L	B	H	i1	i2	h1	for VL/NC Jaw width
9.3285.6006	40	15	16,5	3	18	11,5	100
9.3285.6008	50	19	19	3	23	14	125
9.3285.6010	60	28	22	6	22	17	160

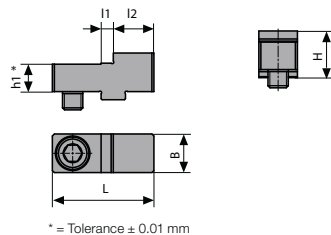

Jaw insert for fixed jaw and slide, HM coated

Part no.	L	B	H	i1	i2	h1	for VL/NC Jaw width
9.3285.6007	40	15	16,5	5	15	11,5	100
9.3285.6009	50	19	19	6	20	14	125
9.3285.6011	60	28	22	7	24	17	160

all dimensions in mm



ROEMHELD
HILMA ■ STARK

HILMA Accessories

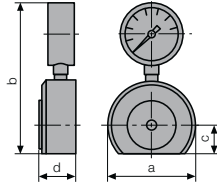

Load cell

for regular checks of the clamping force of hydraulic and mechanical clamping systems.

Part no.	Display range kN	a	b	c	d	For jaw width
2.9501.0001	0 – 60	88	150	29	37	100/125/160

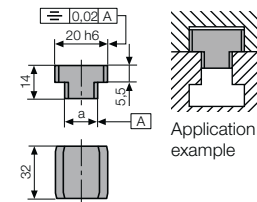

Set of key blocks DIN 6323

For precise alignment of the clamping device on the machine table the key blocks are inserted laterally.

Part number for 2 off = 1 set	Table slot a
9.3917.4121	14 h6
9.3917.4141	18 h6

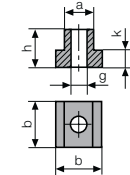

Set of T-nuts DIN 508

Part number for 4 off = 1 set	a	b	g	h	k
9.3777.3211	14	22	M 12	16	8
9.3777.3231	18	28	M 12	20	10
9.3777.3311	18	28	M 16	20	10

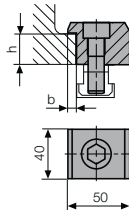

Set of clamping claws with screws

Part number for 4 off = 1 set	h	Socket head cap screw DIN 912
9.3777.2011	24	M 12 x 45 8.8
9.3777.3011	27	M 12 x 45 8.8
9.3777.3021	27	M 16 x 50 8.8

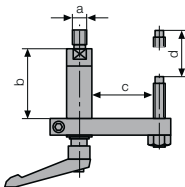

Precision workpiece stop

pivoting, rapid fixation, adjustment in 2 levels.

Part no.	For jaw width	a	b	c	d
9.3291.0201	100/125	M 12	61	95	46
9.3291.0401	160	M 20	81	124	66

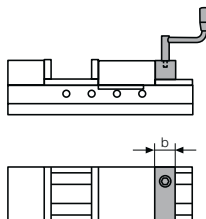

Angle drive

for machine vices and clamping systems of the type mechanic-hydraulic. May be used when normal operation is difficult or even impossible. Ideal for retrofitting.

Part no.	For jaw width	SW	b	Crank radius
9.3294.0505	100	10	39	125
9.3294.0605	125	10	43	125
9.3294.0705	160	10	46	125



6-stage clamping force preselection

retrofitable for hydro-mechanical vices

Part no.	For jaw width
9.3762.0100	100
9.3762.0125	125
9.3762.0160	160

all dimensions in mm

Application examples



ROEMHELD
HILMA ■ STARK

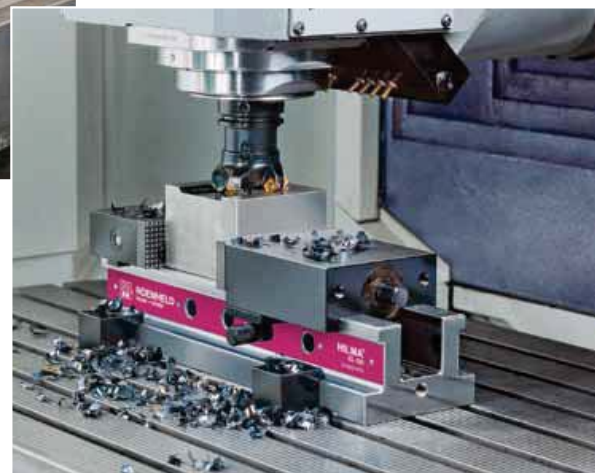



ROEMHELD
HILMA ■ STARK

KNC back to back



DS hydraulic with floating jaws

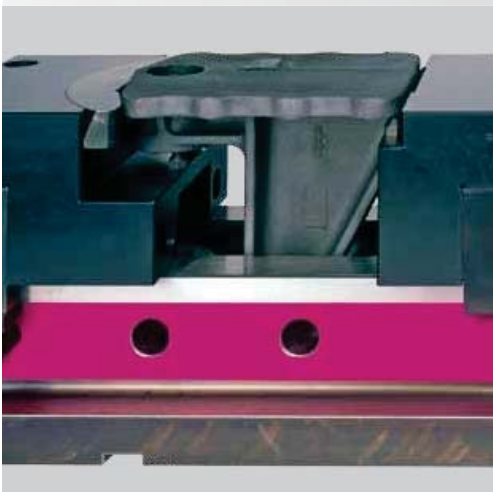

NC with special clamping jaws



MC for 5-sided machining

Products | for | productivity