



Workholding Systems

HILMA KNC

05/2014

Products | for | productivity

1.3150



ROEMHELD
HILMA ■ STARK

HILMA KNC

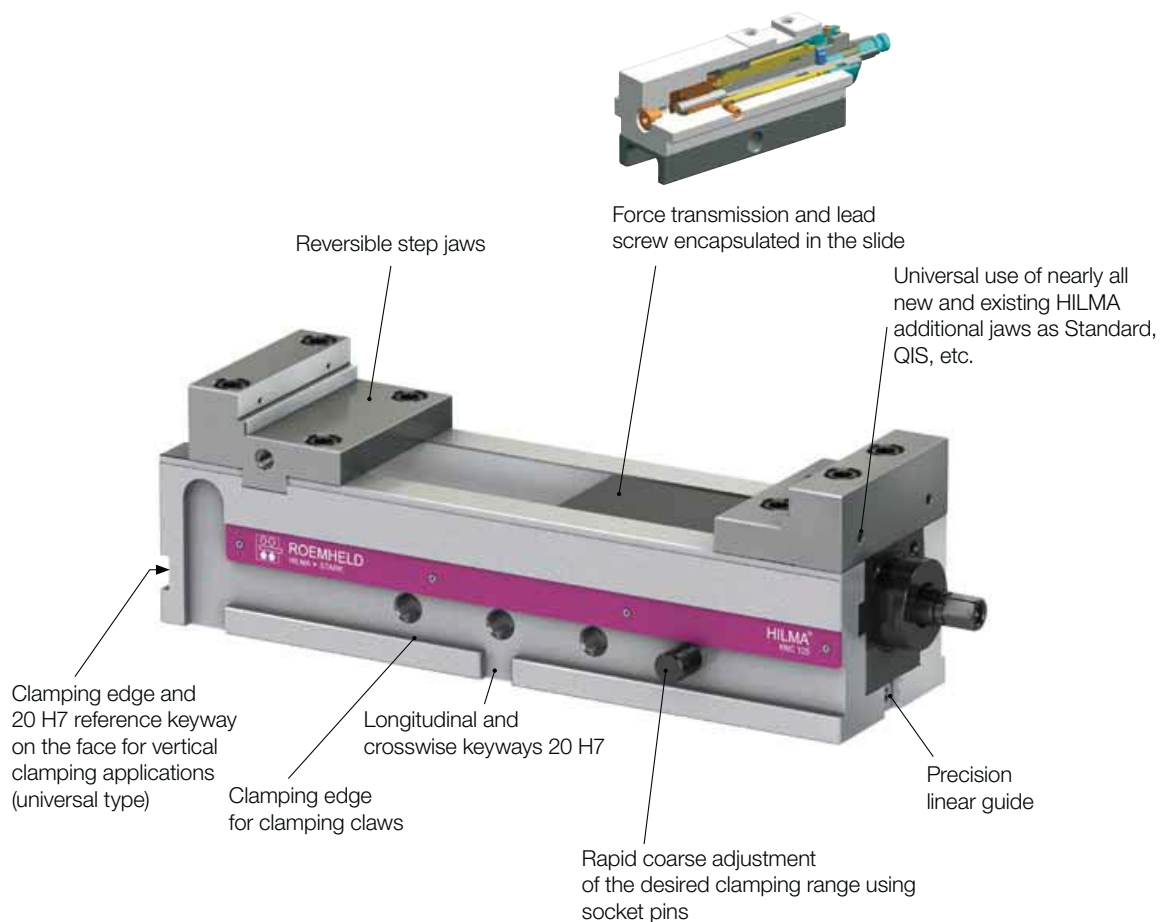

Your benefits at a glance:

- ★ Highest precision
- ★ Universal use
- ★ High process safety
- ★ Simple and quick cleaning
- ★ Quick adjustment of the clamping range by socket pins



For highest demands!

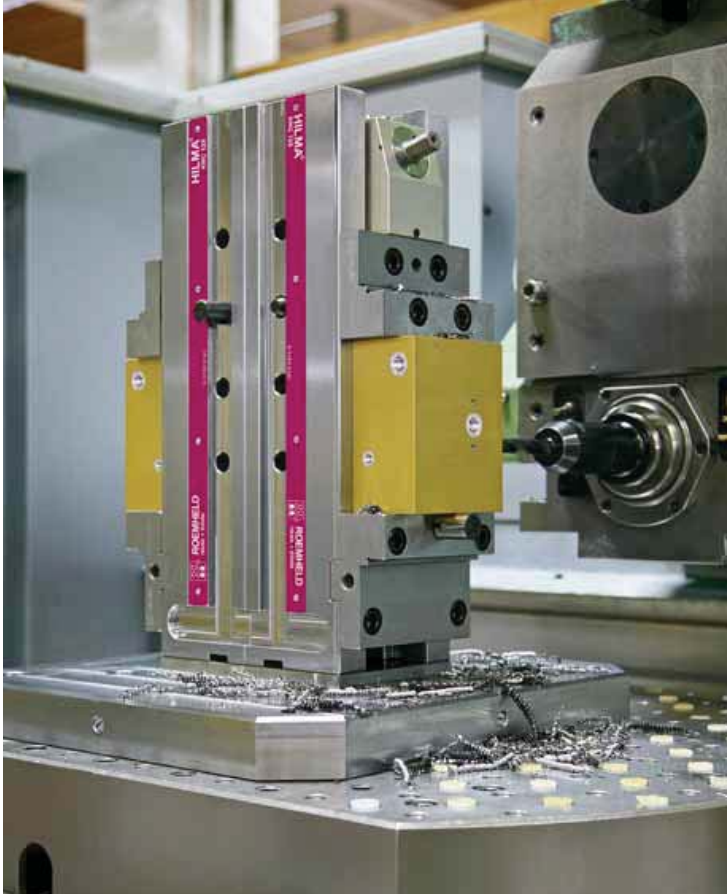

KNC Universal
horizontal arrangement with angle drive



KNC Universal
vertical arrangement with block jaws



KNC Universal
lateral arrangement with reversible
step jaws

Steel base resistant to deformation, an optimum fixation of the fixed jaw and the long inside linear guide ensure maximum precision.

The use of nearly all known and already existing EL/NC clamping jaws as well as of the extensive range of KNC clamping jaws enables universal use.

Thanks to the completely encapsulated force transmission and lead screw, maximum process safety is obtained. No disturbing accumulation of swarf.

The removal of the slide facilitates a simple and quick cleaning of the clamping system. Thus cost intensive downtimes will be reduced.

Thanks to the quick adjustment by socket pins proven for decades, a quick adaptation to very different clamping ranges is possible with minimum effort on the crank handle.



ROEMHELD
HILMA ■ STARK

Technical Data HILMA KNC mechanical-hydraulic

KNC machine vice mechanical-hydraulic for tool making, mould making, construction of jigs and fixtures and production

The machine vice for exacting demands on clamping quality. The mechanical-hydraulic force transmission and the lead screw are integrated into the slide body and are fully encapsulated. Easy, user-friendly manual clamping using the crank handle. 6-stage clamping force selection and angle drive are available as optional extras which may be retrofitted. The steel base with minimum deformation equipped with hardened and ground guideways as well as the linear guide with almost no play of the slide guarantee maximum precision.

KNC Standard horizontal arrangement – with longitudinal and crosswise keyways 20 H7

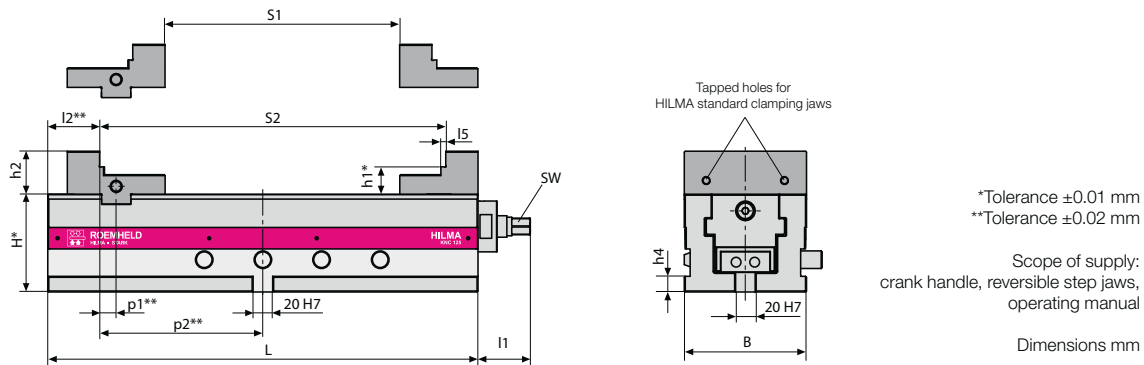

Type	KNC standard Part no.	Clamping force [kN]	Weight [kg]	L	B	H	h1	h2	h4	I1	I2	I5	p1	p2	Jaw opening		SW
															S1	S2	
KNC 100	9.3152.0131	25	17,0	300	100	90	27	33	16	45,4	46	4	14	104	0 – 140	90 – 230	14
KNC 125	9.3153.0131	40	39,5	440	125	100	28	44	16	53,5	53	5	17	167	0 – 240	114 – 354	17
KNC 160	9.3154.0131	50	72,0	540	160	115	37	53	20	53,5	64	6	16	206	0 – 300	136 – 436	17

KNC Universal for horizontal, vertical and lateral arrangement, with longitudinal and crosswise keyways, 20 H7 reference keyway on the face, threaded mounting holes in the base and gas pressure spring for load relief of the slide in vertical arrangement.

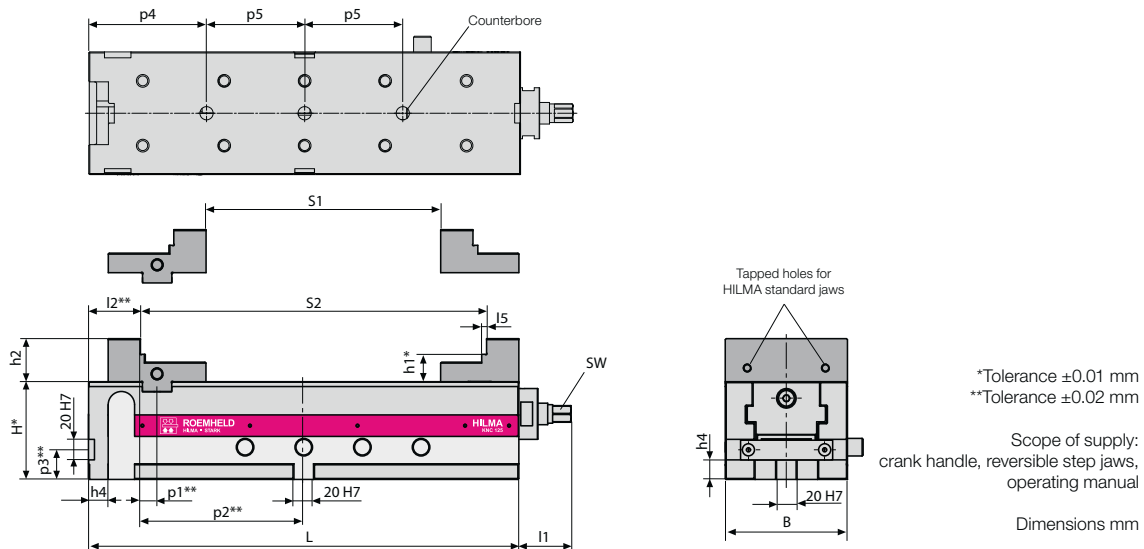

Type	KNC Universal Part no.	Clamping force [kN]	Weight [kg]	L	B	H	h1	h2	h4	I1	I2	I5	p1	p2	p3	p4	p5	Jaw opening		SW
																		S1	S2	
KNC 100	9.3152.0141	25	17,0	300	100	90	27	33	16	45,4	46	4	14	104	28,5	70	2x 80	0 – 140	90 – 230	14
KNC 125	9.3153.0141	40	39,5	440	125	100	28	44	16	53,5	53	5	17	167	30	120	2x 100	0 – 240	114 – 354	17
KNC 160	9.3154.0141	50	72,0	540	160	115	37	53	20	53,5	64	6	16	206	36	170	3x 100	0 – 300	136 – 436	17

HILMA KNC Jaws



ROEMHELD
HILMA ■ STARK

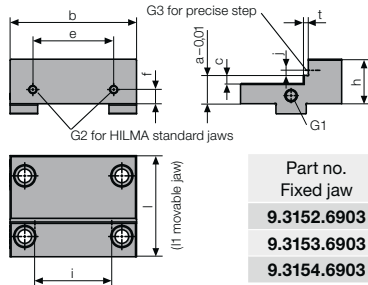

Reversible step jaw (figure shows fixed jaw)

1st side with precise step accommodation, 2nd side with a hole pattern for HILMA QIS jaw system or for fastening quickly interchangeable precise step bars.

Part no. Fixed jaw	Part no. Movable jaw	Dimensions in mm													
		l	l1	b	h	a	c	e	f	t	i	j	G1	G2	G3
9.3152.6903	9.3152.6904	80	60	100	33	27	8	65	11	4	-	-	M12/18	M6/8	-
9.3153.6903	9.3153.6904	100	80	125	44	28	8	80	14	5	76	5	M12/18	M8/11	M4/6
9.3154.6903	9.3154.6904	120	100	160	53	37	9	100	17	6	76	5	M12/18	M10/12	M4/6

Precise step bar

for reversible step jaw and block jaw, hardened

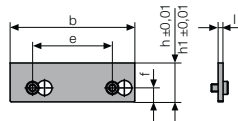

Part no. Precise step h	Part no. Precise step h1	Dimensions in mm					
		l	b	h	h1	e	f
9.3152.6915	9.3152.6916	5	100	28	23,5	65	11
9.3153.6915	9.3153.6916	5	125	39	34	80	14
9.3154.6915	9.3154.6916	5	160	48	43	100	17

Block jaw, hardened (figure shows fixed jaw)

1st side hard-metal coated, 2nd side ground to be smooth, with hole pattern matching the HILMA QIS jaw system and standard jaws

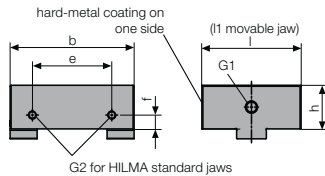

Part no. Fixed jaw	Part no. Movable jaw	Dimensions in mm							
		l	l1	b	h	e	f	G1	G2
9.3152.6901	9.3152.6902	80	60	100	33,5	65	11	M12/18	M 6/8
9.3153.6901	9.3153.6902	100	80	125	44	80	14	M12/18	M 8/11
9.3154.6901	9.3154.6902	120	100	160	53	100	17	M12/18	M10/12

Block jaw soft (figure shows fixed jaw)

non-hardened, for milling workpiece contours, steps with stops etc.. Material 42 CrMo 4

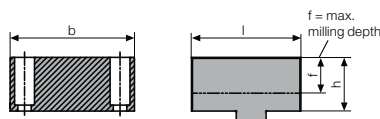

Part no. Fixed jaw	Part no. Movable jaw	Dimensions in mm				
		l	l1	b	h	f
9.3152.6905	9.3152.6906	90	70	100	44	27
9.3153.6905	9.3153.6906	110	90	125	54	35
9.3154.6905	9.3154.6906	130	110	160	63	37

Clamping jaw, extra high with jaw insert grip

(figure shows fixed jaw) **Use locking device!**

Whether for compensating for non-parallel clamping surfaces, powerful clamping in the case of small clamping edge or for providing different precise step accommodations: just change the bar to create a multitude of different jaw variants.

Jaw insert standard: 1st side grip texture, 2nd side smooth for precise steps. Jaw inserts are easily changed and can be designed, with certain limits, individually.

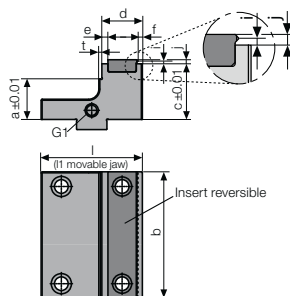

Part no. Fixed jaw	Part no. Movable jaw	Dimensions in mm										
		l	l1	b	a	c	e	f	i	j	t	G1
9.3152.6911	9.3152.6912	84	63	100	37	52	65	4,5	2,5	4	3	M12/18
9.3153.6911	9.3153.6912	100	80	125	40	55	80	4,5	2,5	4	3	M12/18



ROEMHELD
HILMA ■ STARK

HILMA KNC Jaws

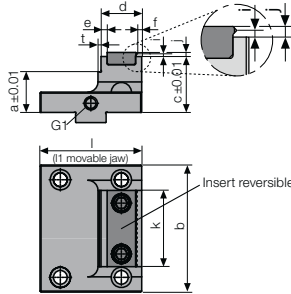

Clamping jaw, extra high with jaw insert grip, various widths

(figure shows fixed jaw) **Use locking device!**

Whether for compensating for non-parallel clamping surfaces, powerful clamping in the case of small clamping edge or for providing different precise step accommodations: just change the bar to create a multitude of different jaw variants.

Jaw insert standard: 1st side grip texture, 2nd side smooth for precise steps. Interchangeable inserts are easily changed and can be designed, with certain limits, individually.

Part no.	Part no.	Dimensions in mm											
Fixed jaw	Movable jaw	l	l1	b	a	c	e	f	i	j	k	t	G1
9.3152.6913	9.3152.6914	84	63	100	37	52	6	4,5	2,5	4	62	3	M12/18
9.3153.6913	9.3153.6914	100	80	125	40	55	6	4,5	2,5	4	75	3	M12/18

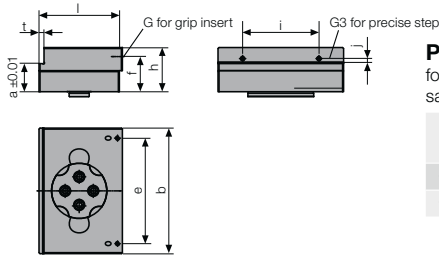

Pendulum jaw

for compensation of non-parallel clamping surfaces, saw cuts or non-parallel surfaces on drawn materials

Part no.	Dimensions in mm										
Fixed jaw	l	b	h	a	e	f	i	j	t	G	G1
9.3153.6908	83	125	44	28	105	35	76	5	5	10	M4/6
9.3154.6908	104	160	53	37	140	44	76	5	6	10	M4/6

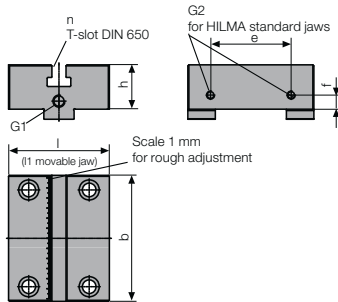

SlimFlex clamping jaw (figure shows fixed jaw)

e.g. for working with clamping base. Gives free room for spindle and tool. Available with stepped inserts as well as with prismatic and soft inserts!

Part no.	Part no.	Dimensions in mm									
Fixed jaw	Movable jaw	l	l1	b	h	e	f	n	G1	G2	
9.3152.6909	9.3152.6910	80	60	100	33,5	65	11	12	M8/14	M6/8	
9.3153.6909	9.3153.6910	100	80	125	44	80	14	14	M12/18	M8/11	
9.3154.6909	9.3154.6910	120	100	160	53	100	17	14	M12/18	M10/12	

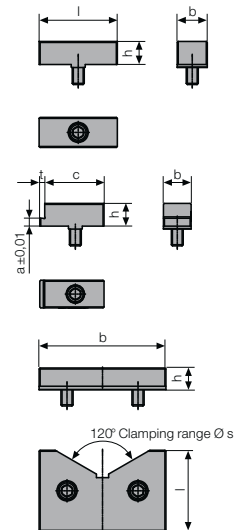

SlimFlex insert, soft

Part no.	Dimensions in mm			For jaw width
	l	b	h	
9.3285.8014	60	30	23	100
9.3285.8009	78	30	23	125 / 160

SlimFlex insert, stepped

Part no.	Dimensions in mm					For jaw width
	a	b	c	h	t	
9.3285.8013	8	23	50	23	5	100
9.3285.8010	8	28	60	23	5	125 / 160

SlimFlex insert, prismatic

Part no.	Dimensions in mm				For jaw width
	l	b	h	s	
9.3285.8012	60	100	18	50-140	100
9.3285.8011	80	125	18	60-150	125 / 160

HILMA standard jaws



ROEMHELD
HILMA ■ STARK

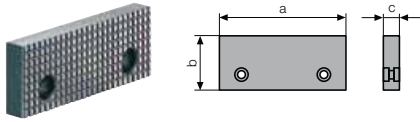

Standard jaw smooth/serrated

Part no.	a	b	c
5.2058.1003	100	34	13
5.2058.1004	125	45	15
5.2058.1005	160	54	18

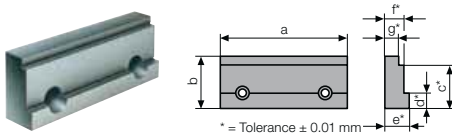

Precision step jaw

Part no.	a	b	c	d	e	f	g
5.2082.0001	100	34	29	10	19	15	11
5.2082.0002	125	45	39	13	25	20	16
5.2082.0003	160	54	45	15	25	20	16

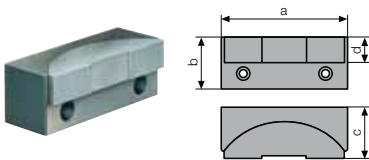

Pendulum jaw

Part no.	a	b	c	d
8.3711.0208	100	34	35	16
8.3711.0308	125	45	50	22
8.3711.0408	160	54	55	26

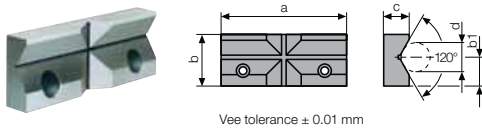

Vee jaw

Part no.	a	b	b1	c	d
5.3030.0002	100	34	19	17	8 – 35
5.3030.0003	125	45	27	19	10 – 50
5.3030.0004	160	54	32	21	12 – 60

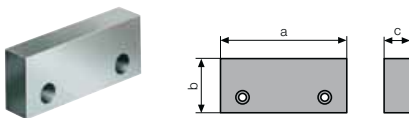

Clamping jaw, soft

Part no.	a	b	c
5.2055.0097	100	36	20
5.2055.0098	125	47	25
5.2055.0099	160	56	30

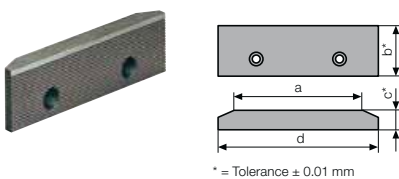

Clamping jaw extra large

Part no.	a	b	c	d
5.2058.1025	100	34	13	125
5.2058.1026	125	45	15	160
5.2058.1027	160	54	20	200

all dimensions in mm



ROEMHELD
HILMA ■ STARK

HILMA QIS Jaws

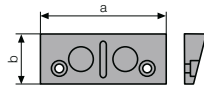

QIS base jaw with permanent magnets

Part no.	a	b	
9.3771.0201	100	34	
9.3771.0301	125	45	
9.3771.0401	160	54	

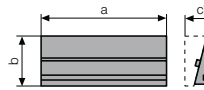

* = Tolerance ± 0.01 mm

QIS interchangeable jaw, smooth

Part no.	a	b	c
8.3771.1201	100	34	21
8.3771.1301	125	45	26
8.3771.1401	160	54	31

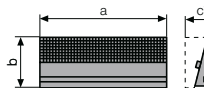

* = Tolerance ± 0.01 mm

QIS interchangeable jaw, serrated

Part no.	a	b	c
8.3771.2201	100	34	21
8.3771.2301	125	45	26
8.3771.2401	160	54	31

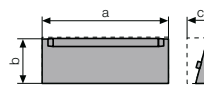

QIS interchangeable jaw, crowned

Part no.	a	b	c
8.3771.3211	100	32,5	23,0
8.3771.3311	125	43,0	27,3
8.3771.3411	160	51,0	31,9

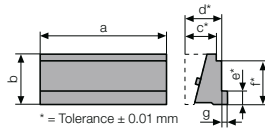

* = Tolerance ± 0.01 mm

QIS interchangeable jaw, stepped

Part no.	a	b	c	d	e	f	g
8.3771.4201	100	34	21	25	10	29	4
8.3771.4301	125	45	26	30	13	39	5
8.3771.4401	160	54	31	35	15	45	5

all dimensions in mm

Mount magnetic base jaw



Approach the QIS jaw in parallel and insert the jaw guided by a locating pin



Jaw change in a few seconds:

Push up the QIS jaw to the end of the slot and tilt

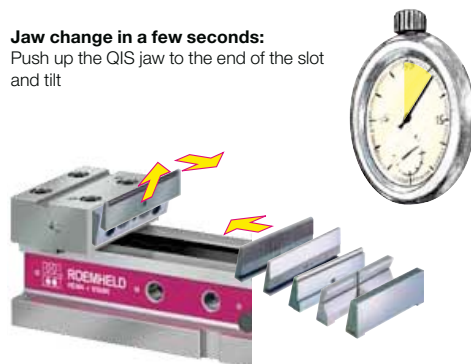

HILMA Accessories



ROEMHELD
HILMA ■ STARK

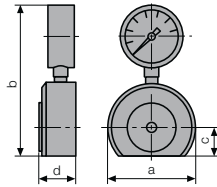

Load cell

for regular checks of the clamping force of hydraulic and mechanical clamping systems.

Part no.	Display range kN	a	b	c	d	For jaw width
2.9501.0001	0 – 60	88	150	29	37	100/125/160

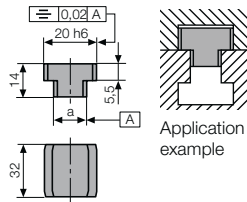

Set of key blocks DIN 6323

for precise alignment of the clamping device on the machine table the key blocks are inserted laterally.

Part number for 2 off = 1 set	Table slot a
9.3917.4121	14 h6
9.3917.4141	18 h6

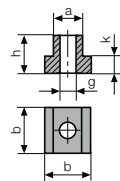

Set of T-nuts DIN 508

Part number for 4 off = 1 set	a	b	g	h	k
9.3777.3211	14	22	M 12	16	8
9.3777.3231	18	28	M 12	20	10
9.3777.3311	18	28	M 16	20	10

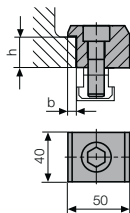

Set of clamping claws with screws

Part number for 4 off = 1 set	for type	Slot	b	h	Socket head cap screw DIN 912
9.3777.3051	KNC 100 KNC 125	14	6	16	M 12 x 30 8.8
9.3777.3061	KNC 100 KNC 125	18	6	16	M 16 x 40 8.8
9.3777.3031	KNC 160	14	7	20	M 12 x 35 8.8
9.3777.3041	KNC 160	18	7	20	M 16 x 40 8.8

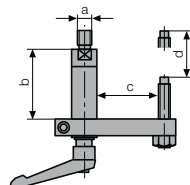

Precision workpiece stop

pivoting, rapid fixation, adjustment in 2 levels

Part no.	For jaw width	a	b	c	d
9.3291.0201	100 / 125 / 160	M 12	61	95	46
9.3291.0401	nur EL / NC 160	M 20	81	124	66

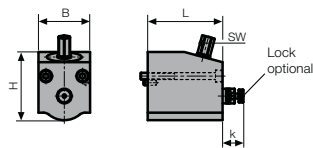

Angle drive

without locking device, for subsequent fitting

Part no.	for type	L	B	H	k	SW
9.3294.0251	KNC 100	85	54	76	22,5	14
9.3294.0352	KNC 125/ KNC 160	90	62	82	24	14

Locking device for KNC angle drive for subsequent fitting



Part no.	for type
9.3152.0529	KNC 100
9.3153.0529	KNC 125/ KNC 160

Locking device for subsequent fitting



Part no.	for type
9.3152.0528	KNC 100
9.3153.0528	KNC 125/ KNC 160

Clamping force preselection incl. locking device, for subsequent fitting



Part no.	for type
9.3762.0251	KNC 100
9.3762.0351	KNC 125/ KNC 160

all dimensions in mm



ROEMHELD
HILMA ■ STARK

Application examples clamping jaws

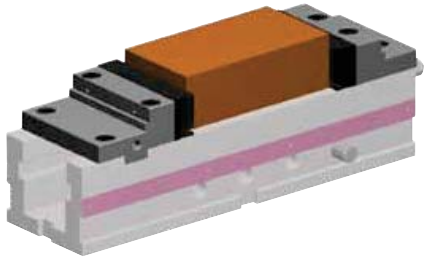

Insert with QIS clamping jaws

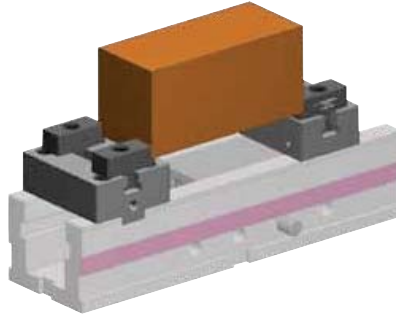

SlimFlex jaw with movable inserts

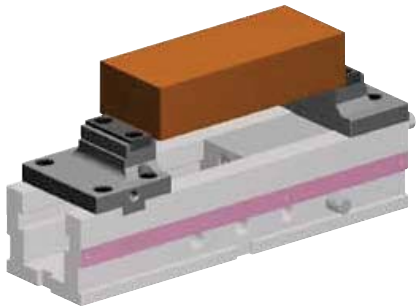

Clamping jaws with reduced width for narrow workpieces

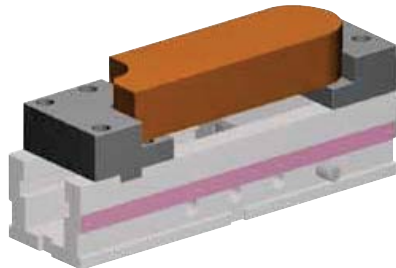

Soft clamping jaws with workpiece contours

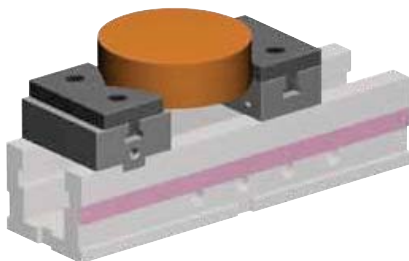

SlimFlex jaw for round workpieces

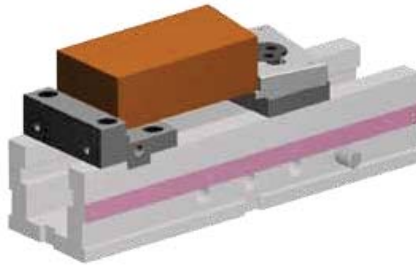

Pendulum jaw to compensate angular errors

Application examples



ROEMHELD
HILMA ■ STARK

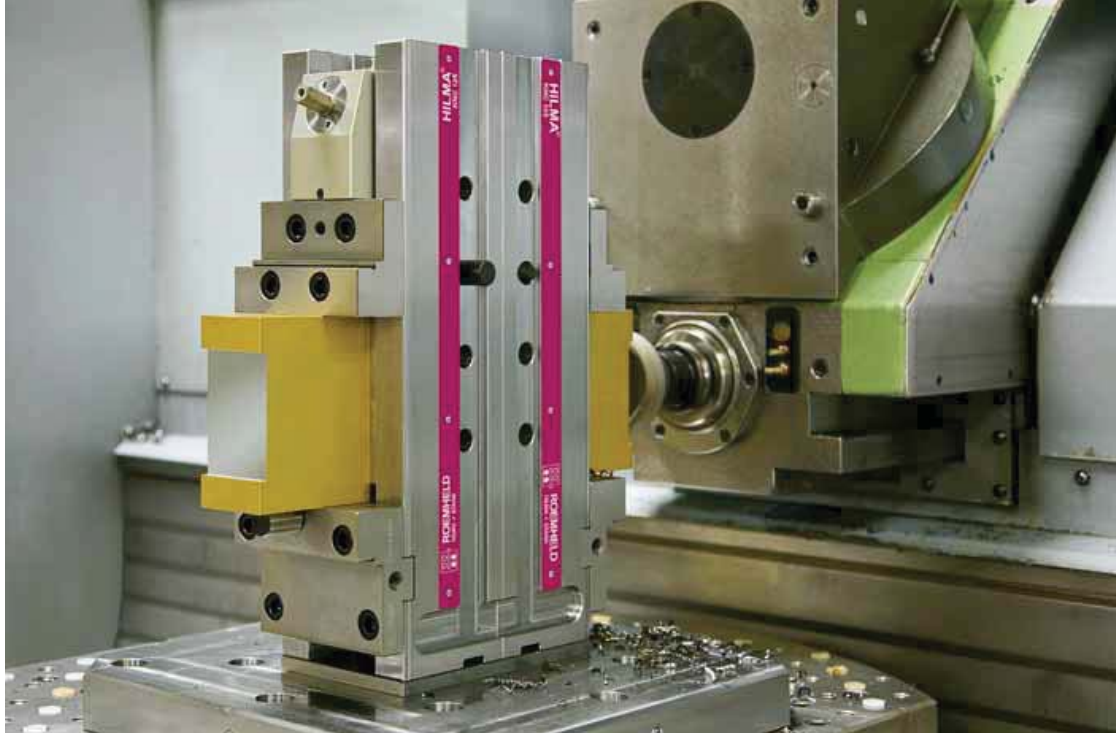



ROEMHELD
HILMA ■ STARK

NC with clamping force display



DS hydraulic with floating jaws

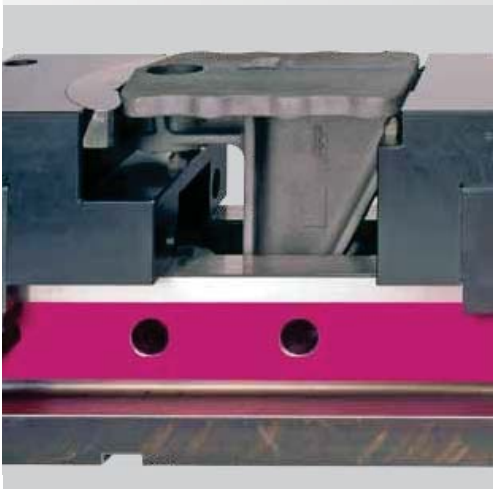
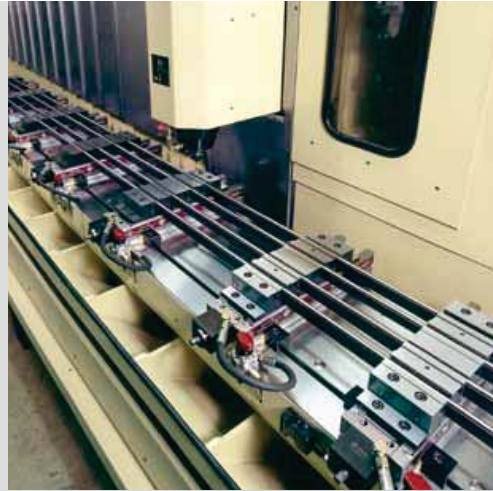

NC with special clamping jaws



MC for 5-sided machining

Products | for | productivity