

Electric Drives  
and Controls

Hydraulics

Linear Motion and  
Assembly Technologies

Pneumatics

Service

**Rexroth**  
Bosch Group

## Digital axis control

Type VT-HNC100...3X

**RE 30139-B/10.11**

Replaces: 04.10  
English

### Operating Instructions



The data specified below only serve to describe the product. Any information with regard to use only refers to application examples and recommendations. Data available in catalogs are no guaranteed characteristics. The information given does not exempt the user from making own evaluations and tests. Our products are subject to a natural process of wear and aging.

© This document, as well as the data, specifications and other information set forth in it are the exclusive property of Bosch Rexroth AG. It may not be reproduced or given to third parties without our consent.

The cover shows a sample configuration. The product supplied may therefore differ from the photo shown.

The original operating instructions were prepared in German.

## Inhalt

<b>1 About this document</b> .....	<b>4</b>
1.1 Validity of the documentation.....	4
1.2 Additional documentation.....	4
1.3 Illustration of information .....	5
<b>2 Safety instructions</b> .....	<b>7</b>
2.1 General information on this chapter.....	7
2.2 Intended use .....	7
2.3 Qualification of personnel .....	8
2.4 General safety instructions .....	8
2.5 Product- and technology-related safety instructions.....	9
2.6 Personal safety equipment .....	10
<b>3 Scope of delivery</b> .....	<b>10</b>
<b>4 Information on this product</b> .....	<b>11</b>
4.1 Performance description .....	11
4.2 Product description .....	11
4.3 Product identification.....	13
4.4 Pin assignments.....	14
<b>5 Transport and storage</b> .....	<b>19</b>
5.1 VT-HNC100...3X storage.....	19
<b>6 Assembly</b> .....	<b>20</b>
6.1 Installation conditions.....	20
6.2 Recommended accessories.....	21
6.3 VT-HNC100...3X assembly.....	21
6.4 VT-HNC100...3X mechanical assembly.....	23
<b>7 Commissioning</b> .....	<b>37</b>
7.1 First commissioning .....	37
7.2 Commissioning software WIN-PED® 6 and WIN-PED® 7.....	37
7.3 Installation requirements.....	38
<b>8 Operation</b> .....	<b>41</b>
8.1 Software description .....	41
<b>9 Maintenance and repair</b> .....	<b>42</b>
9.1 Cleaning and care.....	42
9.2 Maintenance .....	42
9.3 Repair .....	42
<b>10 Disassembly and replacement</b> .....	<b>43</b>
10.1 Preparing for disassembly .....	43
10.2 Disassembling the digital axis control.....	43
10.3 Preparing the components for storage/further use .....	43
<b>11 Disposal</b> .....	<b>44</b>
11.1 Environmental protection .....	44
11.2 Return to Bosch Rexroth.....	44
11.3 Packagings .....	44
11.4 Materials used.....	44
11.5 Recycling .....	44
<b>12 Extension and conversion</b> .....	<b>45</b>
<b>13 Troubleshooting</b> .....	<b>45</b>
13.1 How to proceed with troubleshooting.....	45
<b>14 Technical data</b> .....	<b>46</b>
<b>15 Appendix</b> .....	<b>47</b>
15.1 Address directory.....	47

## About this document

# 1 About this document

## 1.1 Validity of the documentation

This documentation is applicable for the digital axis controls VT-HNC100-...-3X/C..., VT-HNC100-...-3X/P..., VT-HNC100-...-3X/N... and VT-HNC100-...-3X/E... of the VT-HNC100 product family of the 3X/... series. .

For the precise identification of the products see chapter 4.3 "Identification of the product" on page 13.

This documentation is intended for assembly fitters, operators and service technicians and plant operators.

This documentation contains important information on the safe and appropriate assembly, transport, electrical connection, commissioning, operation, use, maintenance, disassembly and simple troubleshooting of the product.

- ▶ You should read this documentation thoroughly, and in particular the chapter "Safety instructions" before working with the product.

## 1.2 Additional documentation



Documentations marked with the book symbol  must be available for you before handling the product and must be complied with:

Table 1:

	Title	Document number	Document type
	Digital axis control VT-HNC100...3X	RE 30139	Technical data sheet Available on the Internet under <a href="http://www.boschrexroth.com">www . boschrexroth . com</a>
	Declaration on the environmental compatibility for EMC, climate and mechanical load	RE 30139-U	Environmental statement Available on the Internet under <a href="http://www.boschrexroth.com">www . boschrexroth . com</a>
	Online help in the commissioning software WIN-PED® 6 and/or WIN-PED® 7		Available on the Internet under <a href="http://www.boschrexroth.com/hnc100">www . boschrexroth . com/hnc100</a>
	"First steps" towards WIN-PED		Available on the Internet under <a href="http://www.boschrexroth.com/hnc100">www . boschrexroth . com/hnc100</a>
	General product information on hydraulic products	RE 07008	Available on the Internet under <a href="http://www.boschrexroth.com">www . boschrexroth . com</a>

## 1.3 Illustration of information

Consistent safety notes, symbols, terms and abbreviations are used so that you can quickly and safely work with your product using this documentation. For a better understanding, they are explained in the following sections.

### 1.3.1 Safety instructions



In this documentation, safety instructions are indicated whenever sequences of operations are explained which bear the risk of injury or damage to property. The measures described for preventing these hazards must be observed.

Safety instructions are set out as follows:

 <b>SIGNAL WORD</b>
<b>Type of risk</b>
Consequences in case of non-compliance
▶ Precaution

- **Warning signs:** Draws attention to the hazard
- **Signal word:** Identifies the degree of hazard
- **Type of risk:** Specifies the type or source of the hazard
- **Consequences:** Describes the consequences of non-compliance
- **Precautions:** Specifies how the hazard can be prevented

Table 2: Risk classes according to ANSI Z535.6-2006

Warning sign, signal word	Meaning
 <b>DANGER!</b>	Indicates a dangerous situation which may cause death or severe personal injuries if not avoided
 <b>WARNING</b>	Indicates a dangerous situation which may cause death or severe personal injuries if not avoided
 <b>CAUTION</b>	Indicates a dangerous situation which may cause minor or medium personal injuries if not avoided
<b>NOTE</b>	Damage to property: The product or the environment could be damaged.

### 1.3.2 Symbols

The following symbols indicate notes which are not safety-relevant but increase the understanding of the documentation.

Table 3: Meaning of the symbols

Symbol	Meaning
	If this information is not observed, the product cannot be used and/or operated optimally.
▶	Individual, self-dependent step

## About this document

### 1.3.3 Denominations

The following denominations are used in this documentation:

**Table 4: Denominations**

Denomination	Meaning
VT-HNC100...3X	Digital axis control
WIN-PED®	Operating software WIN-PED® 6 or WIN-PED® 7 for VT-HNC100...3X
RE xxxx	Rexroth document in English language

### 1.3.4 Abbreviations

The following abbreviations are used in this documentation:

**Table 5: Abbreviations**

Abbreviation	Meaning
CAN	Controller AREA Network
CPU	Central Processing Unit
I/O	Input/Output
EMC	Electromagnetic Compatibility
FU	Frequency converter
HMI	Human Machine Interface
HNC	Hydraulic Numerical Control
L	Active Link
NS	Network Status
OK	HNC ready for operation
PC	Personal Computer
RE	Rexroth data sheet in English language
S	Status LED
PLC	Programmable logic controller
USB	Universal Serial Bus
PELV	Protective Extra Low Voltage

## 2 Safety instructions

### 2.1 General information on this chapter

The VT-HNC100...3X axis control has been manufactured according to the accepted rules of current technology. However, there is still the risk of injury and damage to property if you do not observe this chapter and the safety instructions in this documentation.

- ▶ Read these instructions completely and thoroughly before working with the product.
- ▶ Keep this documentation in a location where it is accessible to all users at all times.
- ▶ Always include the required documentation when you pass the VT-HNC100...3X on to third parties.
- ▶ Only operate the VT-HNC100...3X in a technically immaculate condition and as intended, in a safety- and risk-conscious manner, considering these instructions.
- ▶ In case of failures impairing the safety and modifications to the operating behavior, shut down the VT-HNC100...3X immediately and report the failures to the responsible personnel.

### 2.2 Intended use

The VT-HNC100...3X is an electric assembly.

You may use the product as follows:

A VT-HNC100...3X is intended exclusively for integration into a machine or system or to be assembled with other components to form a machine or system. The product may be commissioned only if it is integrated in the machine/system for which it is designed. Observe the operating conditions and performance limits specified in the technical data.

The VT-HNC100...3X is used for the open-loop and closed-loop control of position, pressure, velocity, differential pressure and optional synchronous operation of maximal four electro-hydraulic axes. When using the unit, you moreover need superordinate control logics with corresponding I/O components that in connection with the VT-HNC100...3X are responsible for the holistic control of the machine's motion sequence and also its monitoring as regards safety.

The VT-HNC100...3X must not be used in explosive environments.

The VT-HNC100...3X is designed for professional and not for private use.

Intended use includes having read and understood this documentation, especially the chapter 2 "Safety instructions".

Any use deviating from the intended use is not intended and thus not admissible.

Bosch Rexroth AG does not assume any liability for damages caused by not intended use. The user assumes all risks involved with not intended use.

Not intended use of the product includes:

- Using the digital axis control outside the specified performance limits and operating conditions and in particular the specified environmental conditions;
- Using the digital axis control as safety-related part of controls in the sense of DIN EN ISO 13849. Functional safety must be implemented using appropriate additional components.

## 2.3 Qualification of personnel

The activities described in this documentation require trained knowledge of electric installation, control technology, programming and hydraulics as well as the knowledge of the appropriate technical terms. In order to ensure safe use, these activities may only be carried out by qualified technical personnel or an instructed person under the direction and supervision of a qualified person.

Qualified personnel are those who can recognize potential hazards and apply the appropriate safety measures due to their professional training, knowledge and experience, as well as their understanding of the relevant conditions pertaining to the work to be undertaken. Qualified personnel must observe the rules/laws relevant to the specific subject area.

The operation of the VT-HNC100...3X digital axis control requires the safe handling with the PC program WIN-PED®. A description of the handling of the program WIN-PED® as well as first steps for operation are available on the Internet under <http://www.boschrexroth.com/hnc100>.

We recommend the participation in a product-specific training of Bosch Rexroth.



Rexroth offers training support in specific fields. An overview of the training contents are available on the Internet under:

<http://www.boschrexroth.de/didactic>. Or contact your online support by email under [support.nc-system@boschrexroth.de](mailto:support.nc-system@boschrexroth.de).

## 2.4 General safety instructions

- Observe the applied provisions for the prevention of accidents and for environmental protection.
- Observe the safety regulations and provisions of the country where the product is implemented/used.
- Exclusively use Rexroth products in good technical order and condition.
- Observe all notes on the product.
- Persons who assemble, operate, disassemble or maintain Rexroth products must not consume any alcohol, drugs or pharmaceuticals that may affect their ability to respond.
- Only use accessories and spare parts authorized by the manufacturer.
- Comply with the technical data and ambient conditions indicated in the product documentation.
- The installation or use of inappropriate products in safety-relevant applications could result in uncontrolled operating conditions when being used which in turn could cause injuries and/or damages to property. Therefore please only use a product for safety-relevant applications if this use is expressly specified and permitted in the documentation of the product.
- Do not commission the product until you can be sure that the end product (for example a machine or system) where the Rexroth product is installed complies with the country-specific provisions, safety regulations and application standards.
- Please observe the safety-relevant information and risk specifications in the operating instructions of the manufacturer of the connected hydraulic system before commissioning the control with a hydraulic system.
- Please observe the general installation and safety instructions when working on electric systems.

- The information given in the product documentation with regard to the use of the supplied components are only application samples and recommendations. The machine manufacturer and system installer must check the suitability of the supplied components and the information given in this documentation with regard to their use self-dependently for his individual application and adjust it to the safety instructions and standards valid for his application, and carry out the required measures, changes and amendments.
- Technical data as well as connection and installation conditions are available in the product documentation and must be imperatively observed.
- In case of failures impairing the safety and modifications to the operating behavior, shut down the VT-HNC100...3X immediately and report the failures to the responsible personnel.
- You must generally not modify or retrofit the product.

## 2.5 Product- and technology-related safety instructions

### • Dangerous motions

It is not allowed for persons to stay within the range of motion of machines and machine parts. The following are examples of possible measures against unintended access of persons:

- Protective fences
- Protective grids
- Protective covers
- Light barrier

- If persons must access the danger zone during active control, monitoring or measures must be provided for personal safety which are superior to the system. These measures must be provided according to the specific data of the system and on the basis of the risk and failure analysis of the system manufacturer/user. In this connection, the safety requirements applied for the system must be taken into account.
- The VT-HNC100...3X itself does not include any safety functions for personal safety and is no safety-relevant component. The VT-HNC100...3X is only used to control the position, pressure, force and velocity of hydraulic axes for machine functions.
- In case of failures impairing the safety and modifications to the operating behavior, shut down the VT-HNC100...3X immediately and report the failures to the responsible personnel.

### • High electric voltage as a result of incorrect connection!

Danger to life, risk of injuries caused by electric shock!

- Only use power packs with protective extra-low voltage (PELV) and/or if they are safely separated from the mains circuits. For further information please see IEC 60204-1.
- All connections and clamps with voltages between 0 and 50 Volt may only be connected with devices, electric components and lines with a protective extra-low voltage (PELV).
- Only connect voltages and electric circuits provided with a safe isolation from dangerous voltages. Safe electrical isolation can be achieved for example with isolating transformers, safe optocouplers or mains-free battery operation.

## Scope of delivery

### 2.6 Personal safety equipment

Check specified personal protection for completeness and protective effect and have it available (please observe customer requirements and personal protection list!)

## 3 Scope of delivery

The delivery contents include:

- VT-HNC100...3X
- Mating connector for X1S (Type Phoenix Mini Combicon 3-pole)
- Mating connector for X2D (Type Phoenix Micro Combicon 6-pole or Phoenix Mini Combicon 12-pole)
- Mating connector X2A (Type Phoenix Micro Combicon 8-pole or HD-SUB 15-pole)
- Mating connector X8M (Type Phoenix Micro Combicon 8-pole or HD-SUB 15-pole)

Accessories such as interface cables and cable sets are not included in the scope of delivery and must be ordered separately. See chapter 6.2 "Recommended accessories" on page 21.

## 4 Information on this product

### 4.1 Performance description

The digital axis control VT-HNC100...3X is a programmable NC control designed for one to four controlled electro-hydraulic axes. The VT-HNC100...3X can be connected to a superior control via a bus system (PROFIBUS DP, CANopen or via the Ethernet-capable bus system PROFINET RT) and programmed using a PC and the software program WIN-PED® version 6 and higher. The Ethernet-capable variant requires WIN-PED® 7. TCP/IP is available optionally to a PROFIBUS DP connection, see order option. Using the VT-HNC100...3X it is possible to implement the control of position, pressure, force and velocity, position-dependant braking, alternating control (position/pressure) and the synchronization control of up to 4 axis, also in groups.

### 4.2 Product description

The VT-HNC100...3X is designed for being used in rough industrial environments as regards to interference resistance, mechanical vibration and shock resistance, and climate resistance.

The VT-HNC100...3X includes freely configurable controller variants:

- Position / pressure / force and velocity controller
- Position-dependant braking
- Alternating control (position/pressure)
- Synchronization control up to 4 axes, also in groups

For parameterization and diagnosis, the PC software WIN-PED® 6 or WIN-PED® 7 is used which is available as free download for each control type on the Internet under [www.boschrexroth.com/hnc100](http://www.boschrexroth.com/hnc100). This allows for the individual parameterization of the VT-HNC100...3X and its adjustment to the requirements of your axes.

The chapter "First steps" describes the first steps when using the PC program WIN-PED®. This chapter is also available as download on the same Internet site.

For process connection, the VT-HNC100...3X digital axis control is provided with digital and analog transducer interfaces and up to eleven freely configurable digital inputs/outputs. A bus system is available for the communication with the superior control.

When using the unit, you moreover need superior control logics with corresponding I/O components that in connection with the VT-HNC100...3X are responsible for the holistic control of the machine's motion sequence and also its monitoring as regards safety.

Information on this product

Setup example



Higher-level control (PLC or PC) and visualization (HMI)

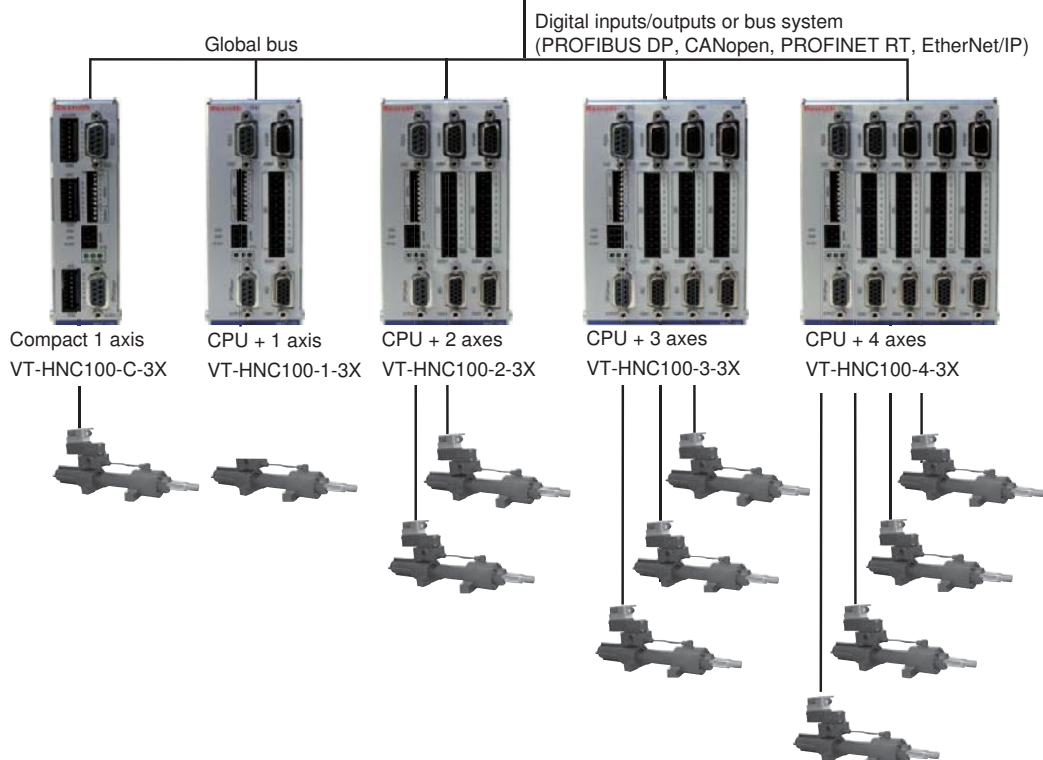

Fig. 1: System setup

The main operating ranges of VT-HNC100...3X include machine tools, plastic machines, special-purpose machines, presses and transfer systems.

The technology functions include:

- Process programming
- Positioning
- Pressure/force control
- Differential pressure control
- Synchronization
- Curves
- Cams



Information on this product

## 4.4 Pin assignments

### 4.4.1 Pin assignment VT-HNC100-C-3X/... (Compact)



The pins marked with “reserved” are reserved and must not be connected!

X8M	Encoder
Pin	
8	Shield
7	24 Venc
6	+5 V
5	- Clk
4	+ Clk
3	- Data
2	+ Data
1	EGND

X2D	DIO (digital)
Pin	
8	Shield
7	OUT2
6	OUT1
5	IN4
4	IN3
3	IN2
2	IN1
1	DGND

X2A	AIO (analog)
Pin	
8	Shield
7	24 Vsens
6	Vout1 +
5	Vout2 +
4	Vin1
3	Cin2 +
2	Cin1 +
1	AGND

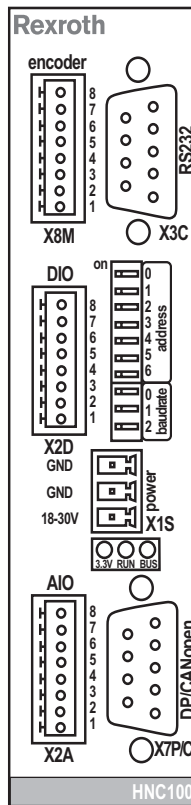

X3C	RS232
Pin	
1	
2	TxD
3	RxD
4	reserved
5	GND
6	reserved
7	reserved
8	reserved
9	

X1S	Power
Pin	
1	GND
2	GND
3	18 - 30 V

X7P	PROFIBUS DP
Pin	
1	reserved
2	reserved
3	RxD/TxD-P
4	CNTR-P
5	DGND
6	VP
7	reserved
8	RxD/TxD-N
9	reserved

X7C	CANopen
Pin	
1	reserved
2	CAN_L
3	CAN_GND
4	reserved
5	reserved
6	reserved
7	CAN_H
8	reserved
9	reserved

### 4.4.2 Pin assignment VT-HNC100-1-3X/... (1-axis version)



The pins marked with "reserved" are reserved and must not be connected!

X3C RS232	
Pin	
1	
2	TxD
3	RxD
4	reserved
5	GND
6	reserved
7	reserved
8	reserved
9	

X1S Power	
Pin	
1	GND
2	GND
3	18 – 30 V

X7E1, X7E2	
Ethernet connection	

X7P PROFIBUS DP	
Pin	
1	reserved
2	reserved
3	RxD/TxD-P
4	CNTR-P
5	DGND
6	VP
7	reserved
8	RxD/TxD-N
9	reserved

X7C CANopen	
Pin	
1	reserved
2	CAN_L
3	CAN_GND
4	reserved
5	reserved
6	reserved
7	CAN_H
8	reserved
9	reserved

Slot 1 X8M1 Encoder		
	Incremental	SSI
Pin 1	- B (Inc)	
2		+ CLK (SSI)
3	+ R (Inc)	
4	- R (Inc)	
5	+ A (Inc)	
6	- A (Inc)	
7		- CLK (SSI)
8	+ B (Inc)	
9		- Data (SSI)
10	EGND	
11		+ Data (SSI)
12	+5 Venc	
13	+10 Vref	
14	+24 Venc	
15	reserved	

Slot 1 X2D1 DIO (Digital)		
Pin		
1	I/O 1	
2	I/O 2	
3	I/O 3	
4	I/O 4	
5	I/O 5	
6	I/O 6	
7	I/O 7	
8	I/O 8	
9	I/O 9	
10	I/O 10	
11	I/O 11	
12	DGND	

Slot 1 X2A1 AIO (Analog)		
Pin		
1	Vin1 +	
2	Vin1 -	
3	Vin2 +	
4	Vin2 -	
5	Cin1 +	
6	Cin1 -	
7	Cin2 +	
8	Cin2 -	
9	reserved	
10	AGND	
11	Vout1 +	
12	Vout2 +	
13	Cout1	
14	+24 Vsens	
15	reserved	

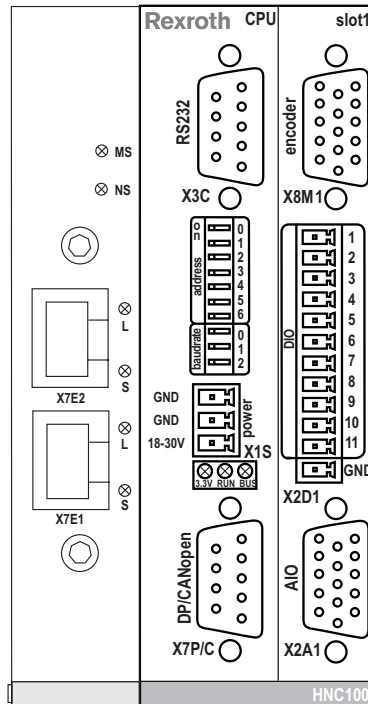

Information on this product

### 4.4.3 Pin assignment VT-HNC100-2-3X/... (2-axis version)



The pins marked with "reserved" are reserved and must not be connected!

X3C	RS232
Pin	
1	
2	TxD
3	RxD
4	reserved
5	GND
6	reserved
7	reserved
8	reserved
9	

X1S	Power
Pin	
1	GND
2	GND
3	18 - 30 V

X7E1, X7E2
Ethernet connection

X7P	PPROFIBUS DP
Pin	
1	reserved
2	reserved
3	RxD/TxD-P
4	CNTR-P
5	DGND
6	VP
7	reserved
8	RxD/TxD-N
9	reserved

X7C	CANopen
Pin	
1	reserved
2	CAN_L
3	CAN_GND
4	reserved
5	reserved
6	reserved
7	CAN_H
8	reserved
9	reserved

Encoder		
Slot 1 X8M1		Slot 2 X8M2
Pin	Incremental	SSI
1	- B (Inc)	
2		+ CLK (SSI)
3	+ R (Inc)	
4	- R (Inc)	
5	+ A (Inc)	
6	- A (Inc)	
7		- CLK (SSI)
8	+ B (Inc)	
9		- Data (SSI)
10	EGND	
11		+ Data (SSI)
12	+5 Venc	
13	+10 Vref	
14	+24 Venc	
15	reserved	

Slot 1 X2D1	DIO <sup>1)</sup> (Digital)	
Pin	1	I/O 1
	2	I/O 2
	3	I/O 3
	4	I/O 4
	5	I/O 5
	6	I/O 6
	7	I/O 7
	8	I/O 8
	9	I/O 9
	10	I/O 10
	11	I/O 11
	12	DGND

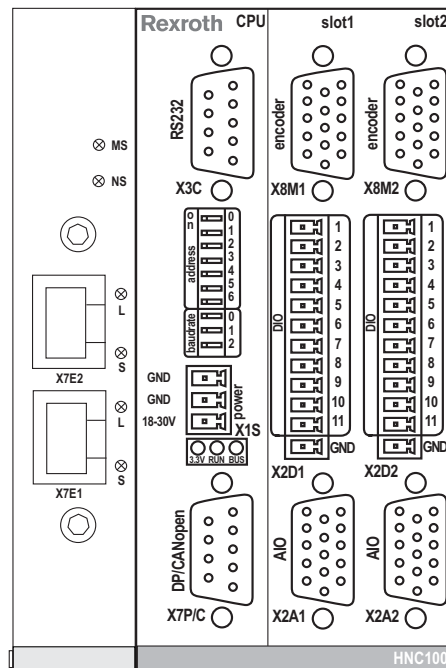

Slot 1 X2A1	AIO (Analog)	
Pin	1	Vin1 +
	2	Vin1 -
	3	Vin2 +
	4	Vin2 -
	5	Cin1 +
	6	Cin1 -
	7	Cin2 +
	8	Cin2 -
	9	reserved
	10	AGND
	11	Vout1 +
	12	Vout2 +
	13	Cout1
	14	+24 Vsens
	15	reserved

<sup>1)</sup> A maximum of 20 digital outputs can be connected.

#### 4.4.4 Pin assignment VT-HNC100-3-3X/... (3-axis version)



The pins marked with "reserved" are reserved and must not be connected!

X3C	RS232
Pin	
1	
2	TxD
3	RxD
4	reserved
5	GND
6	reserved
7	reserved
8	reserved
9	

X1S	Power
Pin	
1	GND
2	GND
3	18 – 30 V

X7E1, X7E2
Ethernet connection

X7P	PROFIBUS DP
Pin	
1	reserved
2	reserved
3	RxD/TxD-P
4	CNTR-P
5	DGND
6	VP
7	reserved
8	RxD/TxD-N
9	reserved

X7C	CANopen
Pin	
1	reserved
2	CAN_L
3	CAN_GND
4	reserved
5	reserved
6	reserved
7	CAN_H
8	reserved
9	reserved

Encoder		
Slot 1 X8M1		
Slot 2 X8M2		
Slot 3 X8M3	Incremental	SSI
Pin	1	- B (Inc)
	2	+ CLK (SSI)
	3	+ R (Inc)
	4	- R (Inc)
	5	+ A (Inc)
	6	- A (Inc)
	7	- CLK (SSI)
	8	+ B (Inc)
	9	- Data (SSI)
	10	EGND
	11	+ Data (SSI)
	12	+5 Venc
	13	+10 Vref
	14	+24 Venc
	15	reserved

Slot 1 X2D1	DIO <sup>1)</sup>
Slot 2 X2D2	(Digital)
Slot 3 X2D3	
Pin	1
	2
	3
	4
	5
	6
	7
	8
	9
	10
	11
	12

Slot 1 X2A1	AIO
Slot 2 X2A2	(Analog)
Slot 3 X2A3	
Pin	1
	2
	3
	4
	5
	6
	7
	8
	9
	10
	11
	12
	13
	14
	15

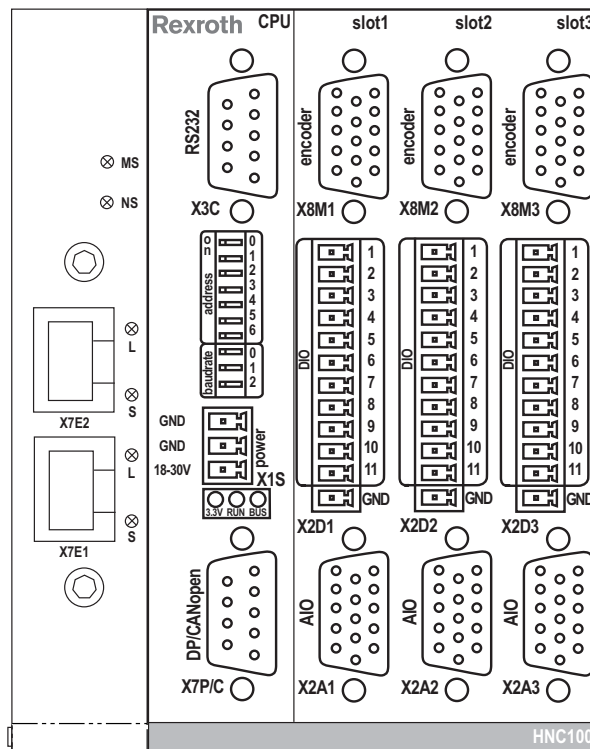

<sup>1)</sup> A maximum of 20 digital outputs can be connected.

<sup>2)</sup> Not available at slot 3 (reserved).

Information on this product

### 4.4.5 Pin assignment VT-HNC100-4-3X/... (4-axis version)



The pins marked with "reserved" are reserved and must not be connected!

X3C RS232	
Pin	
1	
2	TxD
3	RxD
4	reserved
5	GND
6	reserved
7	reserved
8	reserved
9	

X1S Power	
Pin	
1	GND
2	GND
3	18 – 30 V

Encoder			
Slot 1 X8M1		Slot 2 X8M2	
Slot 3 X8M3		Slot 4 X8M4	
	Incremental	SSI	
Pin			
1	- B (Inc)		
2		+ CLK (SSI)	
3	+ R (Inc)		
4	- R (Inc)		
5	+ A (Inc)		
6	- A (Inc)		
7		- CLK (SSI)	
8	+ B (Inc)		
9		- Data (SSI)	
10	EGND		
11		+ Data (SSI)	
12	+5 Venc		
13	+10 Vref		
14	+24 Venc		
15	reserved		

Slot 1 X2D1 DIO <sup>1)</sup>		
Slot 2 X2D2 (Digital)		
Slot 3 X2D3		
Slot 4 X2D4		
Pin		I/O
1		I/O 1
2		I/O 2
3		I/O 3
4		I/O 4
5		I/O 5
6		I/O 6
7		I/O 7
8		I/O 8
9		I/O 9
10		I/O 10
11		I/O 11
12		DGND

Slot 1 X2A1 AIO		
Slot 2 X2A2 (Analog)		
Slot 3 X2A3		
Slot 4 X2A4		
Pin		
1	Vin1 +	
2	Vin1 -	
3	Vin2 +	
4	Vin2 -	
5	Cin1 +	
6	Cin1 -	
7	Cin2 +	
8	Cin2 -	
9	reserved	
10	AGND	
11	Vout1 +	
12	Vout2 + <sup>2)</sup>	
13	Cout1	
14	+24 Vsens	
15	reserved	

X7E1, X7E2	
	Ethernet connection

X7P PROFIBUS DP	
Pin	
1	reserved
2	reserved
3	RxD/TxD-P
4	CNTR-P
5	DGND
6	VP
7	reserved
8	RxD/TxD-N
9	reserved

X7C CANopen	
Pin	
1	reserved
2	CAN_L
3	CAN_GND
4	reserved
5	reserved
6	reserved
7	CAN_H
8	reserved
9	reserved

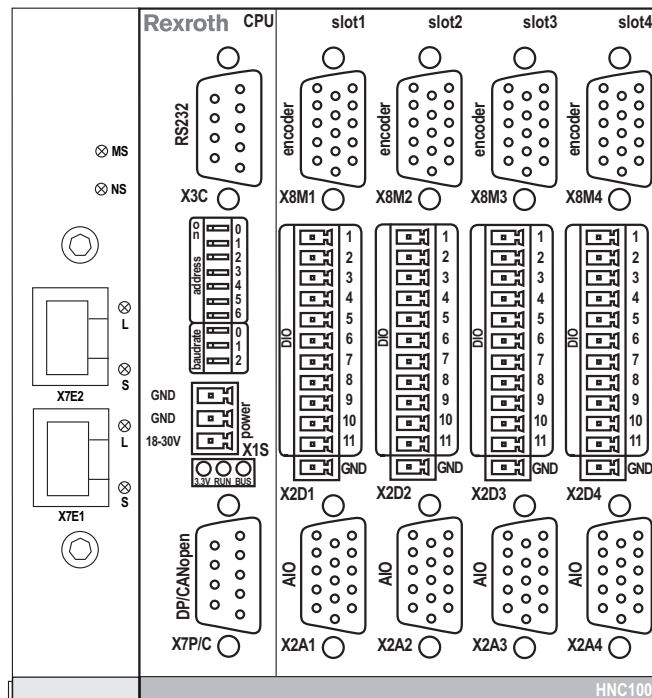

<sup>1)</sup> A maximum of 20 digital outputs can be connected.

<sup>2)</sup> Not available at slot 3 and slot 4 (reserved).

## 5 Transport and storage

There are no special transport instructions for this product. You must, however, observe the notes in chapter 2 "General safety notes" and comply with the ambient conditions for storage and transport which are detailed in the technical data of data sheet 30139.

### 5.1 VT-HNC100...3X storage

Proceed as follows in order to prepare the VT-HNC100...3X for storage and further use:

- ▶ Only use the genuine packaging for storage.
- ▶ Comply with the admissible storage temperature range of  $-20\text{ °C}$  to  $+70\text{ °C}$ .
- ▶ Protect the VT-HNC100...3X from dust and humidity.

## 6 Assembly

### NOTE

#### Risk of short circuit!

Water may condense within the housing!

- ▶ Let the VT-HNC100...3X acclimate itself for several hours, as otherwise water may condense in the housing.

The housing of the VT-HNC100...3X/ is perforated. According to the existing protection class, dirt and fluids may easily enter and cause failures and a short circuit! Safe functioning of the VT-HNC100...3X/ is thus no longer ensured.

- ▶ When working on the VT-HNC100...3X you must make sure that everything is clean and that no fluids will enter the housing.

#### Major potential differences!

Danger of destroying the VT-HNC100...3X by connecting or disconnecting plugs under voltage.

- ▶ Switch off power supply to the relevant system component before assembling the unit or when connecting and disconnecting plug-in connectors.

### 6.1 Installation conditions

- ▶ For installing the product always observe the ambient conditions specified in the data sheet RE 30139.

**NOTE:** The environment must be free from electrically conductive contamination (acids, bases, corrosive agents, salts, metal vapors, etc.) and the device must not be exposed to these substances. Rule out any deposits according to protection class IP 20.

The VT-HNC100...3X is intended for top hat rail assembly in the control cabinet. The dimensions of each version are listed in the data sheet RE 30139.

- ▶ Before commissioning, make sure that all the seals and plug of the plug-in connection are installed correctly to ensure that they are leakproof and fluids and contamination parts are prevented from penetrating the product.

## 6.2 Recommended accessories

The following accessories are recommended for the connection of the VT-HNC100...3X axis control. These accessories are not included in the scope of delivery, and can be ordered separately at Bosch Rexroth.

Table 6: Accessories

Component	Material number
RS232 interface cable, 1:1, length: 3 m	R900776897
USB RS232 converter	R901066684
Cable set VT17220-1X/HNC100...3X, length 2 m, for analog signals (connection X2A) and digital position measurement systems (connection X8M) with HD connector and open breakout cable for: VT-HNC100-1-3X, VT-HNC100-2-3X, VT-HNC100-3-3X, VT-HNC100-4-3X	R901189300
Cable set VT17220-1X/HNC100...3X, length 2 m, for analog signals (connection X2A) and digital position measurement systems (connection X8M) with FK MC connector and open breakout cable for: VT-HNC100-C-3X	R901189302
Plug-in connector Type 6ES7972-0BA42-0XA0 for PROFIBUS DP	R901312863

## 6.3 VT-HNC100...3X assembly

- ▶ Lay the cables and lines so that they cannot be damaged and no one can trip over them.
- ▶ By snapping the housing of the VT-HNC100...3X/ on a conductive assembly rail, the earth connection to the control cabinet rear wall is established. This constitutes the HF earthing of the VT-HNC100...3X.
- ▶ No silicone-containing sealing, adhesive, or insulating agents must be used.
- ▶ Ensure a maintenance-friendly installation, i.e. simple access to the connection lines. Free access to the connection side must be guaranteed.
- ▶ Before installation note down the information on the nameplates. If, after the installation, nameplates are no longer visible or legible, these data will be quickly available to you at any time.

### 6.3.1 Place of installation

Do not install the HNC next to power electronics (e.g. frequency converters, etc.) The power pack of the VT-HNC100...3X should be installed as close to the VT-HNC100...3X as possible.

### 6.3.2 Voltage supply

- ▶ The connection should be as short as possible. Pass supply and return lines (+24 V/GND) together. Voltage 18-30 V with residual ripple < 1.5 Vpp, I = 1 A - 4 A (depends on the HNC variant and the additional supplied components).
- Load lines of two individual wires (e.g. voltage supply) are to be passed in a parallel or drilled form.

## Assembly

### Supply of external components

When supplying a 24 V encoder, the input voltage of the HNC100...3X at X1S must comply with the encoder's requirements (e.g. 24 V +/-5 %, residual ripple < 500 mV).

Analog components like pressure cells can be supplied via the sockets X2A1...4.

Prerequisite: The supply of the VT-HNC100...3X corresponds to the requirements of the pressure cell. Further notes with regard to currents, etc. are available in the data sheet RE 30139.

### 6.3.3 Screening

For signal lines, only cables with a copper braid shield should be used. The cable shield is extensively connected with the metallized connector housing and only on the VT-HNC100...3X side. This is achieved by pushing the screen back and clamping under the pull relief.

### 6.3.4 General notes with regard to wiring

- ▶ Observe the highest possible separation of signal and load lines and do not lay the same parallel.
- ▶ Do not pass the signal lines through strong magnetic fields.
- ▶ Lay signal lines as continuously as possible. If intermediate terminals are required, please use terminal block with shield strip and assembled VT-HNC100...3X cable (max length 2m).  
Exception: VT-HNC100-C-3X (Compact): Here, intermediate clamping using a corresponding terminal block/shield strip is necessary for EMC-compliance. Load lines of two individual wires (e.g. voltage supply) are to be passed in a parallel or drilled form.
- ▶ Cables should have the actually required number of wires only. If this is not possible, you must connect the wires and connect them to the earth on one side in the control cabinet.

### 6.3.5 Troubleshooting the system

In case of faults with the VT-HNC100 signals, you must check the troubleshooting of other electric components, e.g. as follows:

Switched inductivities:	DC: Antiparallel free-wheeling diode over actuator winding AC: Type-related R/C combination over actuator winding.
Electric motors	R/C combination from each motor winding to earth.
Frequency converter	Input filter in the voltage supply of the frequency converter. Motor control line shielded and laid separately from other lines, and/or output filter for motor lines. Extensive contact of the FU housing with the rear wall of the control cabinet

## 6.4 VT-HNC100...3X mechanical assembly

Assemble the VT-HNC100...3X on a top hat rail as follows:

- ▶ Carefully engage the rear wall of the VT-HNC100...3X housing on a top hat rail and check for safe seat. The mechanical contact points on the elastic rear wall of the VT-HNC100...3X allow for a safe seat on the top hat rail and the connection of the housing with the control cabinet's earthing system.

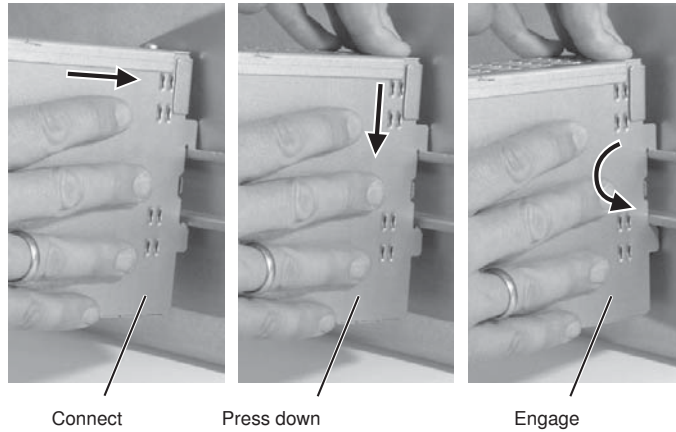

Fig. 3: VT-HNC100...3X assembly on the top hat rail

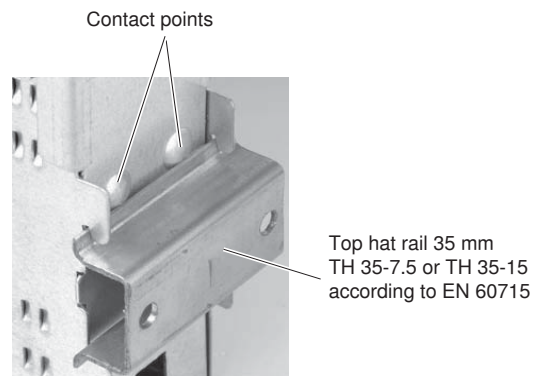

Fig. 4: Contact points of the VT-HNC100...3X for assembly on top hat rail

By snapping the housing of the VT-HNC100...3X/ on a conductive assembly rail, the earth connection to the control cabinet rear wall is established. This constitutes the HF earthing of the VT-HNC100...3X.

## Assembly

### 6.4.1 HNC100...3X wiring

Use of pre-assembled breakout cables at the X8M encoder connector interface and the analog I/O X2A

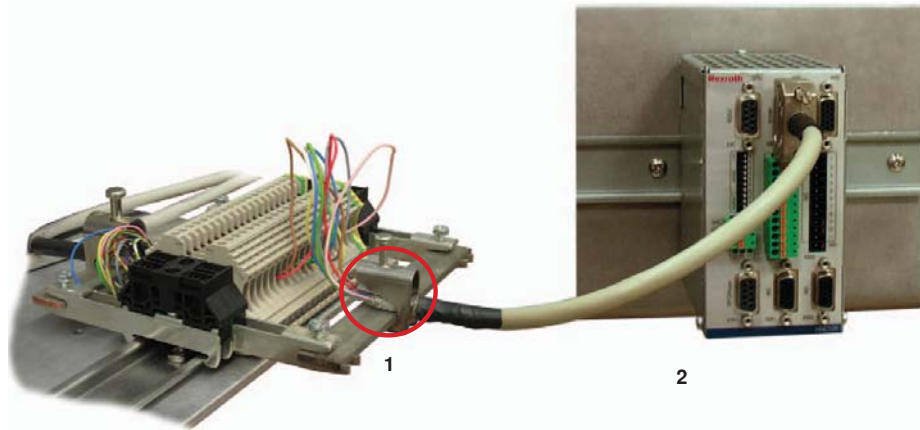

Fig. 5: Breakout cable with HD-SUB, 15-pole

- 1 Shield clamp:**  
The open end of the assembled breakout cable is connected with the terminal block. Using a shield clamp which is adjusted to the shield strip, the pushed back cable shield is pulled extensively to the potential of the control cabinet rear wall, i.e the earth. The low-impedance connection of the conductively coated DIN rail to the control cabinet rear wall is important.
- 2 VT-HNC100...3X shield system**  
The cable shields are connected with the VT-HNC100 housing via the HD-SUB connector. The connection with the control cabinet rear wall is established via the housing and the DIN rail. Metalized D-sub connector housings are used. The cable shield must be pushed back and clamped under the pull relief. See illustration below.

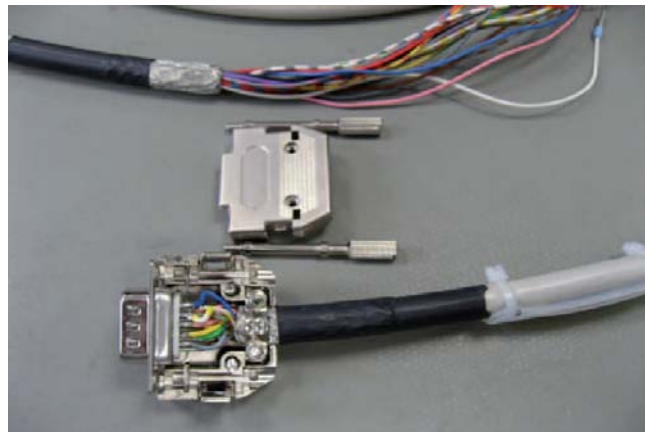

Fig. 6: Breakout cable with 15-pole HD-SUB connector and open cable end

Max. length of the cable: 2 m

**NOTE:** On the side of the breakout cable, all wires must be connected to the terminal strip. Otherwise there is a risk of short circuit!

The earthing of the control cabinet must be considered accordingly.

**Wiring diagram for analog (X2A) or digital interface (X8M)**

VT17220-1X/HNC100...3X & material number: R901189300

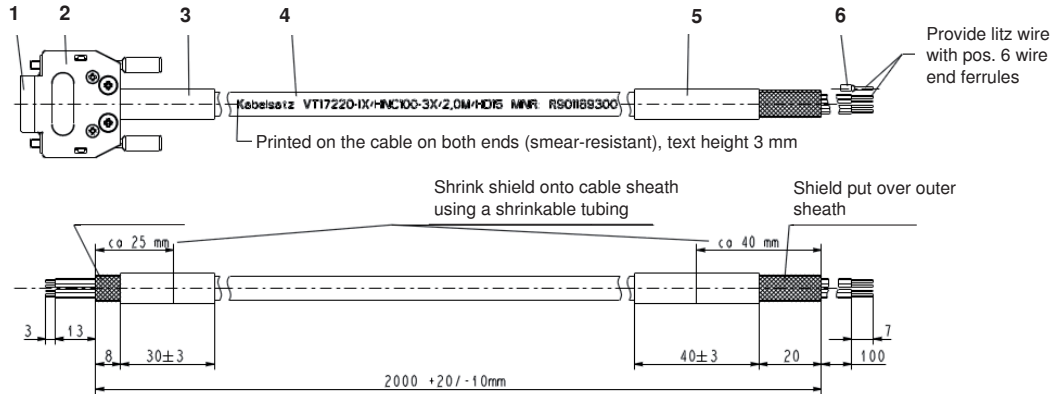

Fig. 7: Wiring diagram for analog or digital interface

- 1 HD sub connector high density 15-pole with solder bucket
- 2 D-SUB housing, 9-pole, metal/UNC (Mat. no. R900016918)
- 3 Shrinkable tubing 30 mm
- 4 Cable Unitronic LiYCY 8 x 2 x 0.14 mm<sup>2</sup>, approx. 2.2 m
- 5 Shrinkable tubing 40 mm
- 6 Wire end ferrules

**NOTE:** Type and manufacturer of item 2 are binding (housing dimensions)!

Assembly

Table 7: Pin assignment

Pin	Color	Slot X2A1		Slot 1 X8M1		
		Pin	AIO (analog)	Pin	Encoder	
1	Black	Pin 1	Vin 1 +	Pin 1	- B	
2	Pink	Pin 2	Vin 1 -	Pin 2		+ CLK
3	Grey/Pink	Pin 3	Vin 2 -	Pin 3	+ R	
4	Red/Blue	Pin 4	Vin 2 -	Pin 4	- R	
5	White/Green	Pin 5	Cin 1 +	Pin 5	+ A	
6	Brown/Green	Pin 6	Cin 1 -	Pin 6	- A	
7	Grey	Pin 7	Cin 2 +	Pin 7		- CLK
8	Violet	Pin 8	Cin 2 -	Pin 8	+ B	
9	Yellow	Pin 9	reserved	Pin 9		- Data
10	White + Blue	Pin 10	AGND	Pin 10	EGND	
11	Green	Pin 11	Vout 1	Pin 11		+ Data
12	Brown	Pin 12	Vout 2	Pin 12	+5 Venc	
13	White/Yellow	Pin 13	Cout 1	Pin 13	+10 Vref	
14	Red	Pin 14	24 Vsens	Pin 14	+24 Venc	
15	Yellow/Brown	Pin 15	reserved	Pin 15	reserved	

VT-HNC100 Compact

HNC100...3X shield system:

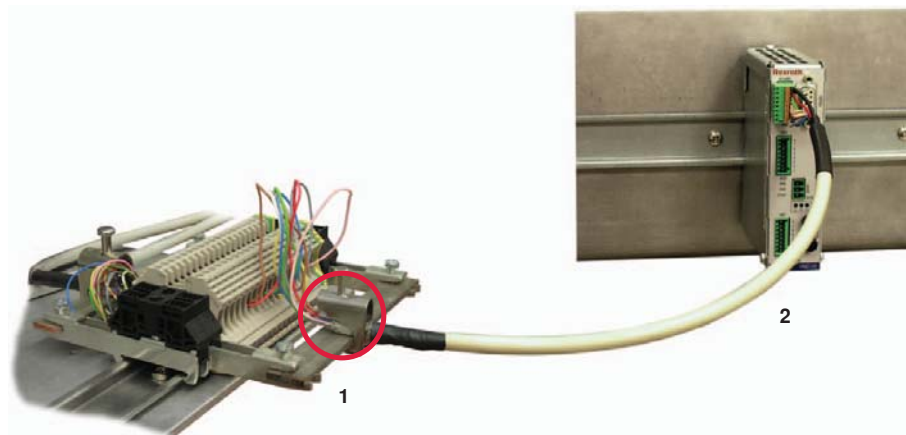

Fig. 8: Breakout cable with micro Combicon connector, 8-pole

- 1 Shield clamp:  
The open end of the assembled breakout cable is connected with the terminal block.  
Using a shield clamp which is adjusted to the shield strip, the pushed back cable shield is pushed extensively to the potential of the control cabinet rear

wall, i.e the earth. The low-resistance connection of the conductibly coated DIN rail taddo the control cabinet rear wall is important.

- 2 VT-HNC100...3X Compact shield system  
The cable shields are connected with the VT-HNC100 housing via the shield pin of the Micro Combicon connector. The connection to the control cabinet rear wall is established via the housing and the DIN rail. An intermediate terminal block with shield strip must be used. See illustration below.

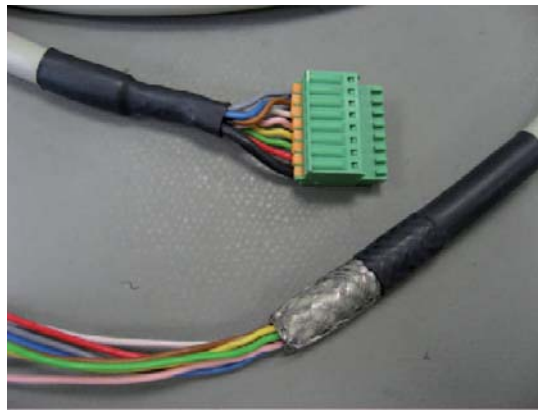

Fig. 9: Micro-Combicon connector and open cable end

**Wiring diagram for analog (X2A) or digital interface (X8M)  
VT17220-1X/HNC100...3X & material number: R901189302**

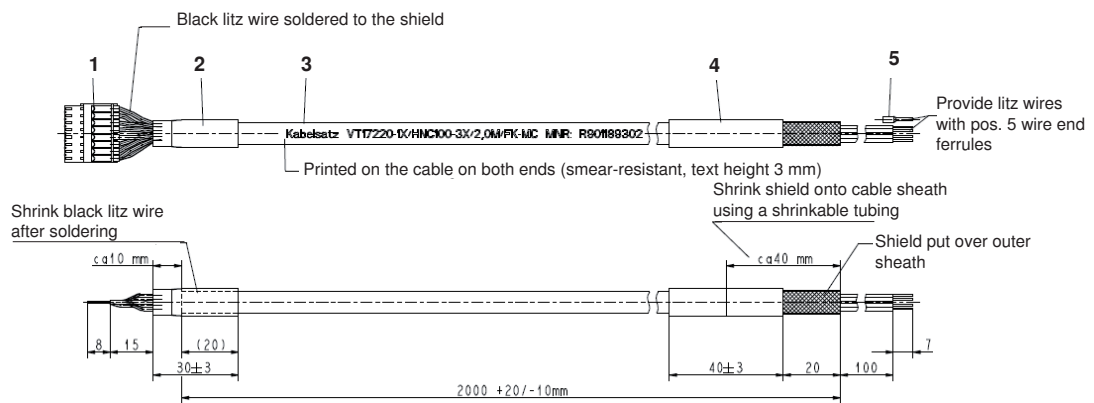
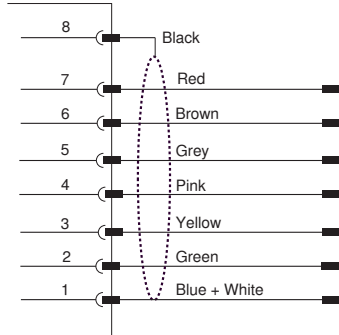

Fig. 10: Wiring diagram for analog or digital interface

- 1 8-pole Micro Combicon connector FK-MC 0.5/-ST-2.5
- 2 Shrinkable tubing 30 mm
- 3 Unitronic LiYCY cable 4 x 2 x 0.25 mm<sup>2</sup>, approx. 2.2 m long
- 4 Shrinkable tubing 40 mm
- 5 Wire end ferrules

Assembly

Table 8: Pin assignment



Slot X8M	Encoder
Pin 8	Shield
Pin 7	24 Venc
Pin 6	+5 V
Pin 5	- Clk
Pin 4	+ Clk
Pin 3	- Data
Pin 2	+ Data
Pin 1	EGND

Slot X2A	AIO (Analog)
Pin 8	Shield
Pin 7	24 Vsens
Pin 6	Vout 1
Pin 5	Vout 2
Pin 4	Vin 1
Pin 3	CIN2 +
Pin 2	CIN1 +
Pin 1	AGND



Assembly

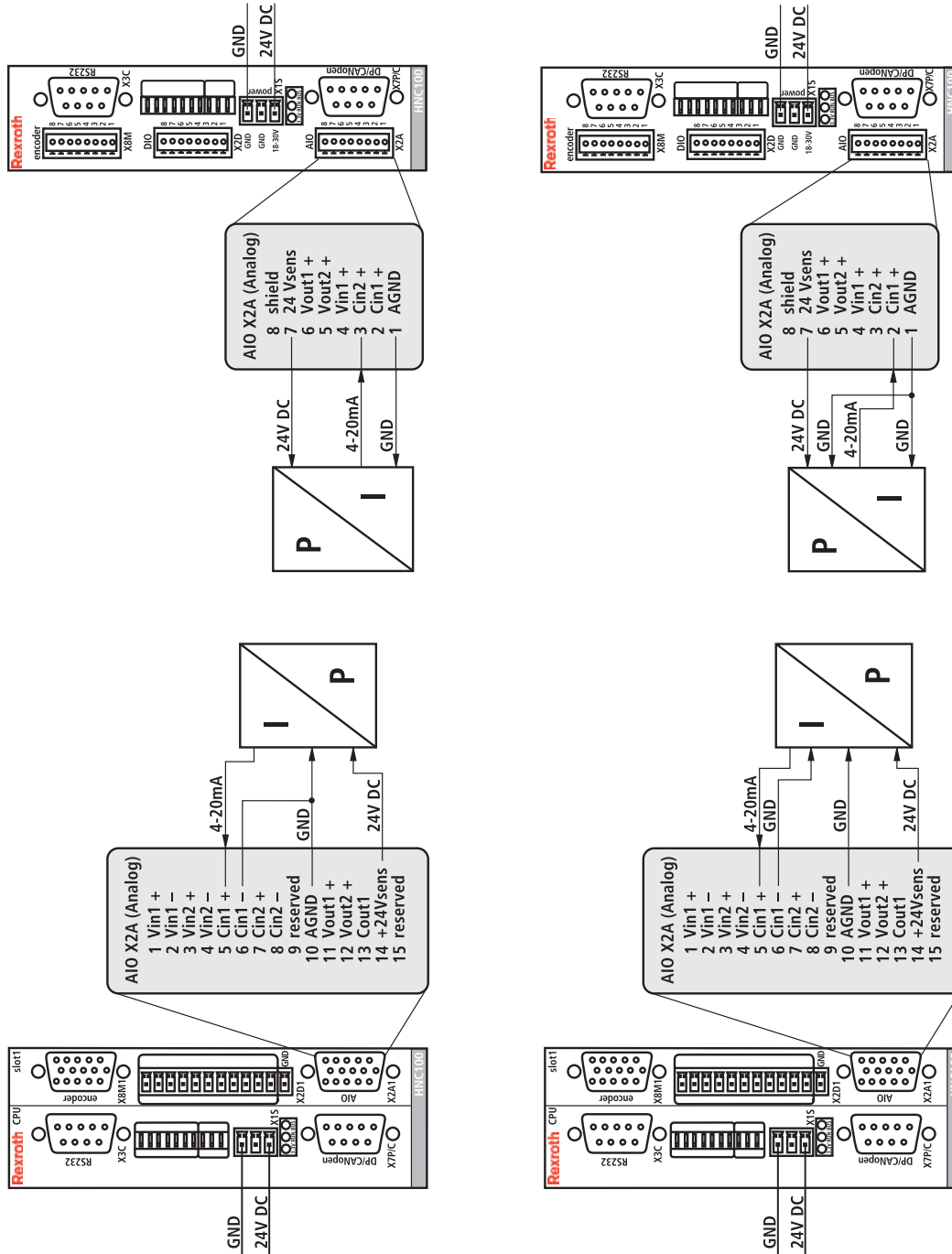

Fig. 12: Wiring for pressure transducers

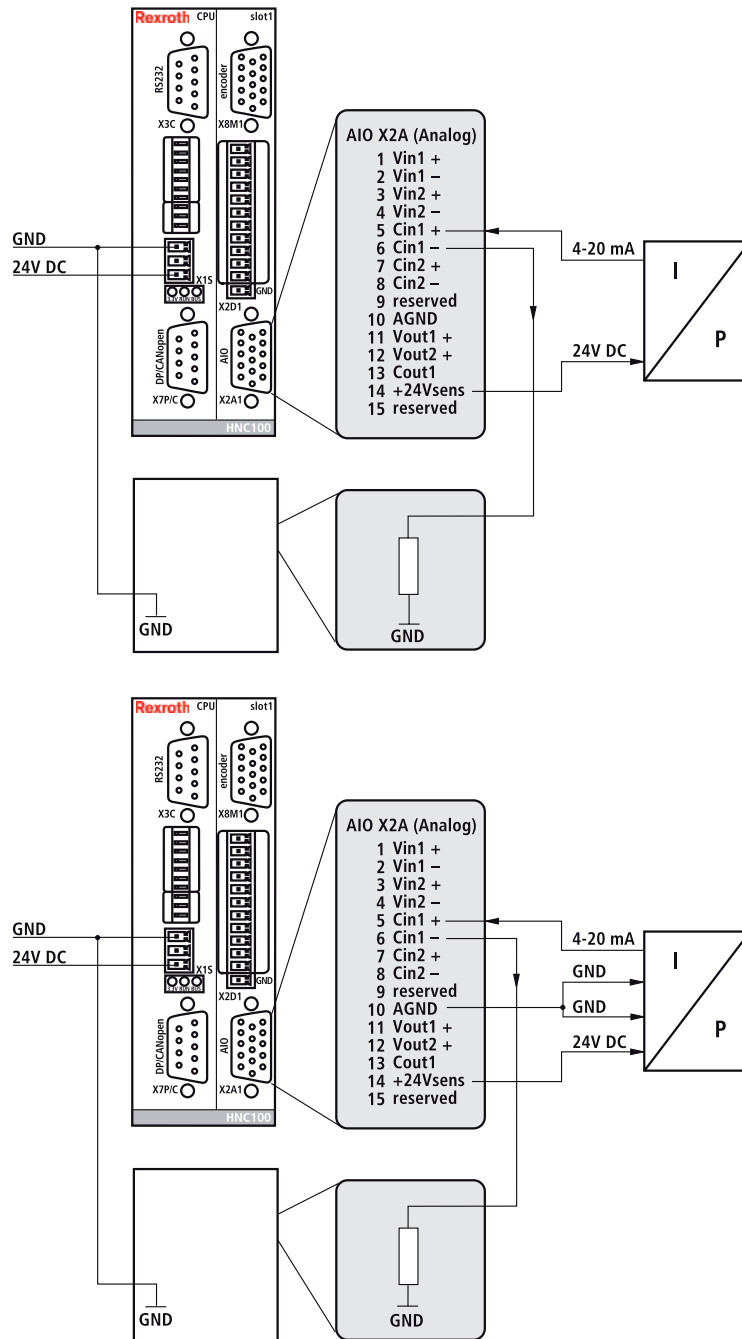

Fig. 13: Forwarding a pressure transducer signal (not for Compact version)

## Assembly

### 6.4.3 Description of the LEDs

At the front side of the VT-HNC100...3X unit, there are the following 3 LED displays:

- 3.3 V: Voltage supply of the VT-HNC100...3X is OK.
- RUN: VT-HNC100...3X has been initialized and is in "RUN". The LED flashes if the VT-HNC100...3X has not been initialized.
- BUS: Field bus communication is OK.

If the following variants are used: HNC with PROFINET RT, EtherNet/IP or PROFIBUS and optionally with TCP/IP, the following additional LEDs are used:

- NS: Network status  
LED off = no IP address  
LED green (flashing) = configuration  
LED green = connection established  
LED red (flashing) = connection interrupted  
LED red = double IP address
- MS: HACD status:  
LED green (flashing) = configuration  
LED green = HACD OK  
LED red (flashing) = error
- L: Link: On = Active; Off = No connection to the communication partner
- S: Transmission status of the data (flashing = Receiving/sending EtherNet telegrams).

### 6.4.4 CANopen

The CANopen interface as well as the operation of the VT-HNC100...3X via CANopen is described in detail in the online help

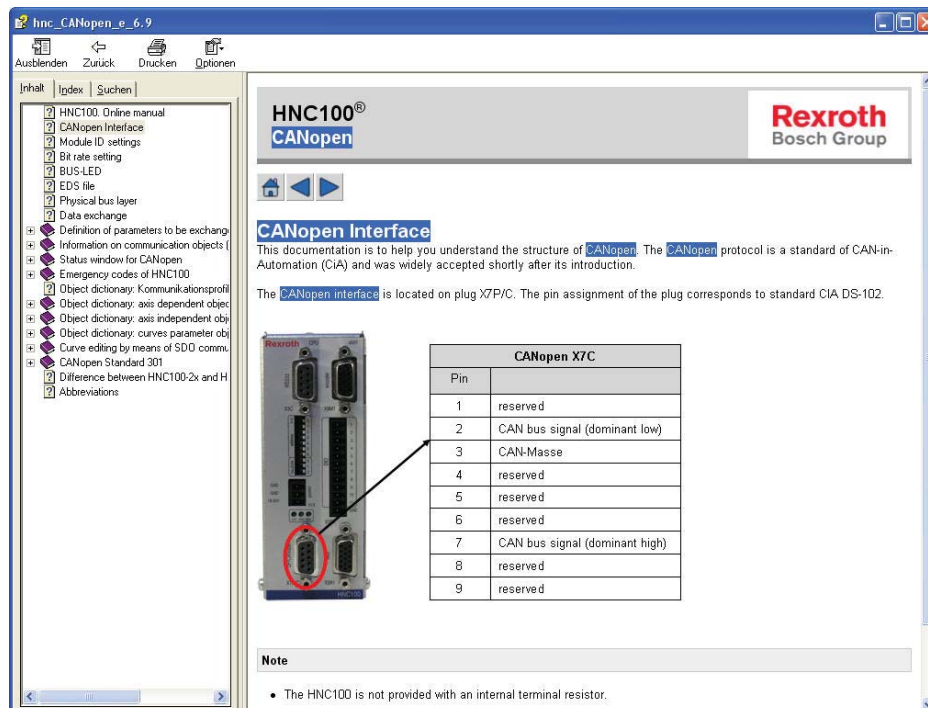

Fig. 14: CANopen interface

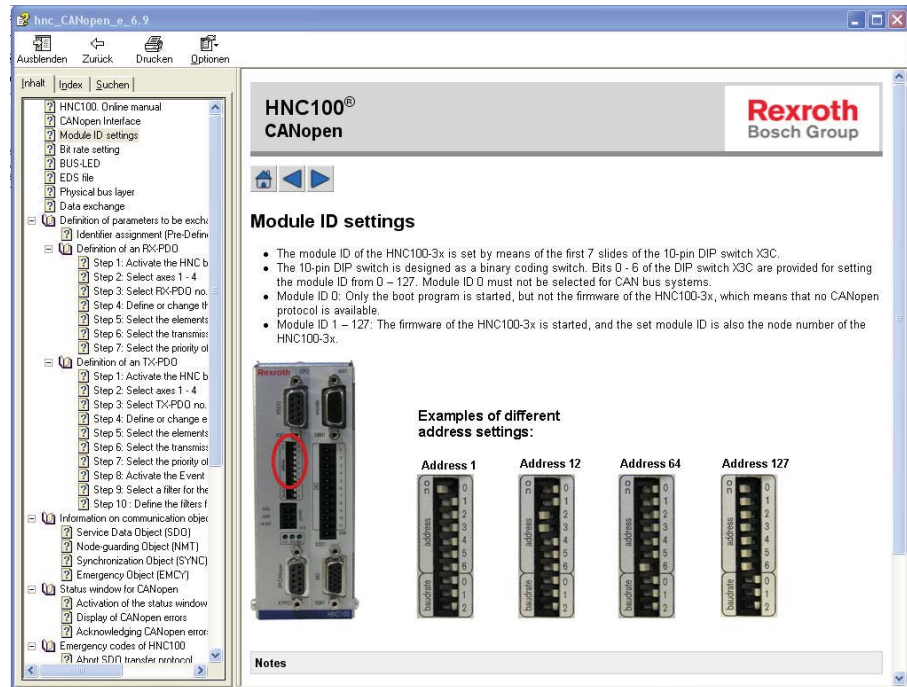

Fig. 15: VT-HNC100 address with CANopen

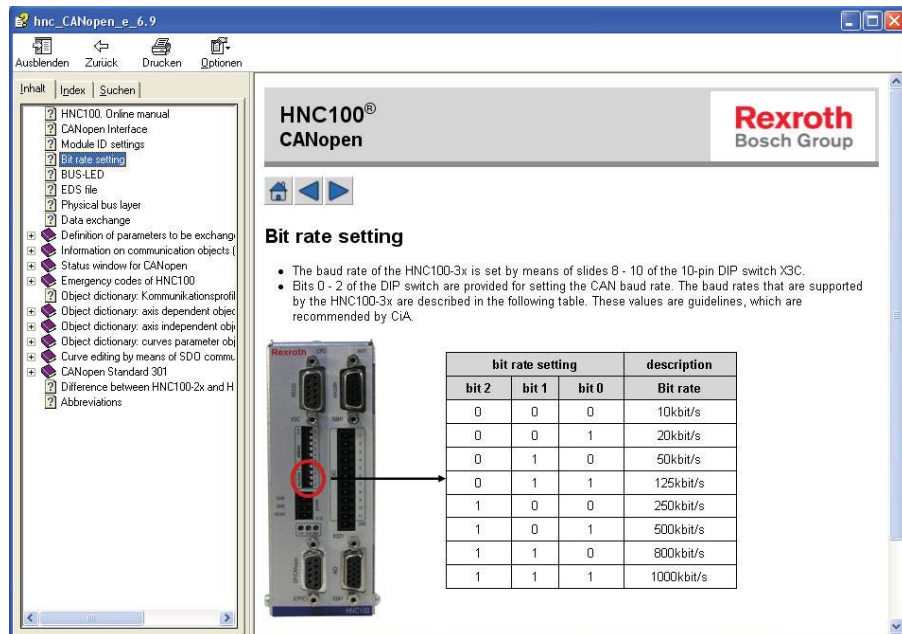

Fig. 16: Baud rate for CANopen

Assembly

### 6.4.5 PROFIBUS DP

The PROFIBUS DP interface as well as the operation of the VT-HNC100...3X via CANopen is described in detail in the online help.

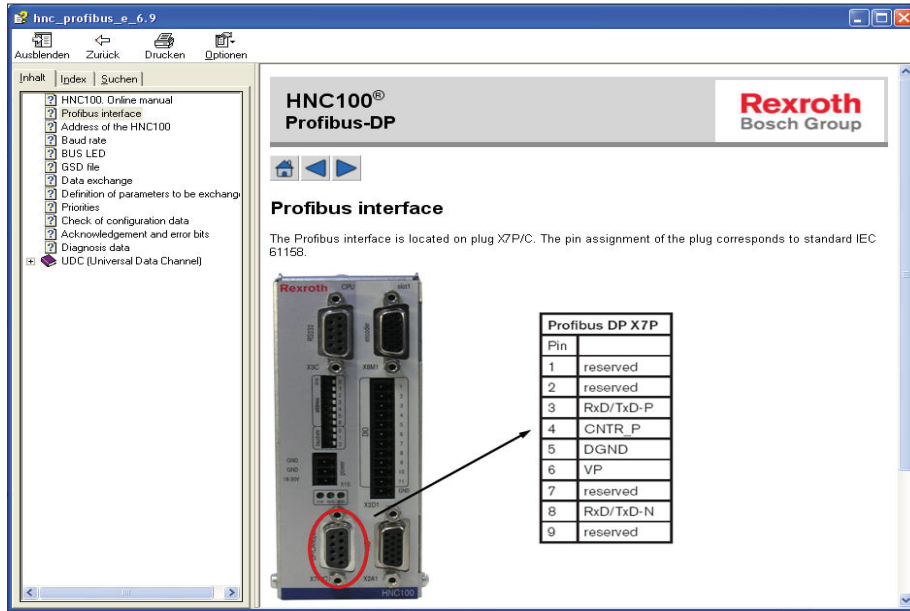

Fig. 17: PROFIBUS DP interface

**HNC100<sup>®</sup> Profibus-DP**

**Address of the HNC100**

The address is set by means of address switch X3C (DIP switch). The address switch allows an address to be selected from 1 to 127.

The individual switches of the address switch have the following valence:

Switch	Valence
0	1
1	2
2	4
3	8
4	16
5	32
6	64

The address is the sum of the individual figures.

**Example of various address switch settings:**

**Address 1**      **Address 12**      **Address 64**      **Address 127**

Fig. 18: Address setting for PROFIBUS DP

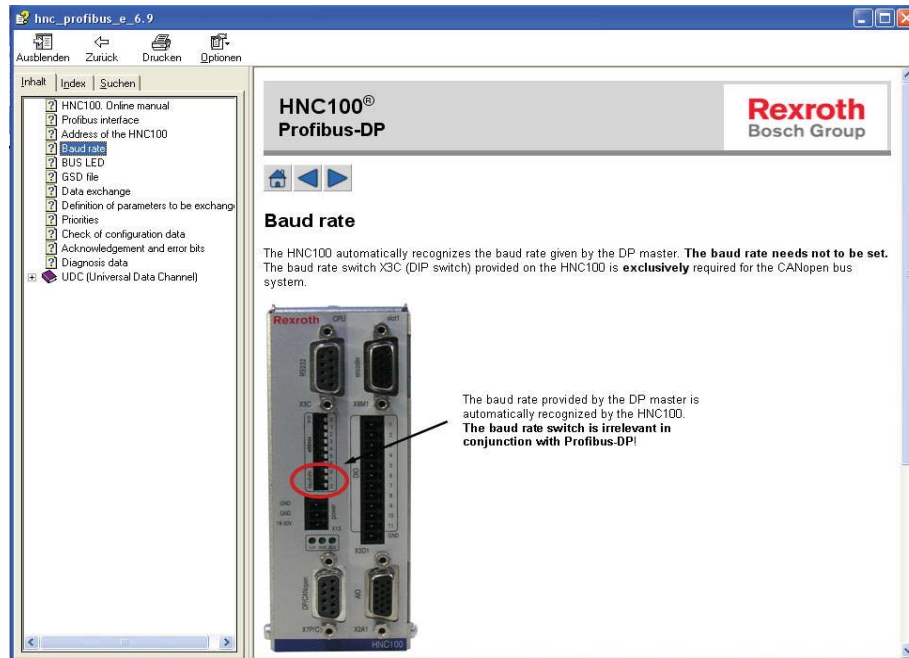

Fig. 19: PROFIBUS DP baud rate

#### 6.4.6 Setting the address switch

The address switch is located at the front side of the housing of the VT-HNC100...3X

A binary setting of 1 to 127 addresses is possible.

In switch position 0 = boot mode, all data can be transferred.

#### 6.4.7 PROFINET RT / EtherNet IP

Here, the IP address is assigned with WIN-PED® 7. The address switch at the front side is without any meaning.

Further information is available in the online help of WIN-PED® 7.

#### 6.4.8 PROFIBUS DP with TCP/IP

Here, the IP address is assigned with WIN-PED® 7. The address switch at the front side is without any meaning.

Further information is available in the online help of WIN-PED® 7.

## 7 Commissioning

### 7.1 First commissioning

#### NOTE

##### Uncontrolled connection or disconnection of plug-in connectors!

The device might be destroyed.

- ▶ Before installation works, and before connecting or disconnecting plug-in connectors to or from the device, the device must be disconnected from the voltage supply or reliably de-energized. Devices damaged due to incorrect installation are not covered by the warranty.
- ▶ Observe protection class, voltage supply and environmental conditions according to data sheet RE 30139.

The basis for the functionality of the VT-HNC100...3X is the preparation of the application with software WIN-PED® 6 or WIN-PED® 7. For operation, the VT-HNC100...3X must be connected with the PC ready for operation, and the PC must be online.



It is also possible, to start the acceptance of existing project data from the VT-HNC100...3X directly from the program WIN-PED® 6.X. In this case too, the VT-HNC100...3X must be connected with the PC ready for operation, and the PC must be online.

- ▶ Select the "Communication" menu.
- ▶ Select "Upload data" and "Search directly connected controls". After the acceptance of the existing project data and the HNC software, the program WIN-PED® 6.X is ready for operation together with the VT-HNC100...3X, and the actual project planning, programming and diagnosis of the control system can be started.



The HNC software version with which the VT-HNC100...3X was initialized, must already be installed on the PC before project data can be acquired.

Further information on operation, project planning, programming and diagnosis of the control system with WIN-PED® 6 is available in the help menus of the program.

### 7.2 Commissioning software WIN-PED® 6 and WIN-PED® 7

For commissioning and for later operation, the user can apply the PC program WIN-PED®. It can be used for the programming, setting and diagnosis of the VT-HNC100...3X. Functionality, menus and program windows are adjusted to the variants of VT-HNC100...3X.

Projects established with WIN-PED® 6 are not compatible with projects from WIN-PED® 7. Automatic conversion is not possible. However, it is possible to edit the projects manually.

Ethernet-capable hardware requires WIN-PED® 7. Any other hardware version operates both with WIN-PED® 6 and WIN-PED® 7.

## Commissioning

WIN-PED® offers the following functions:

- Convenient dialog functions for the online or offline settings of the machine data
- NC editor with integrated syntax check and program compiler
- Support for the definition of the parameters used in the NC program
- Dialog window for the online setting of the parameter values
- Various options for the display of the process parameters for digital inputs, outputs and flags
- Recording and graphic illustrations of up to 16 process parameters with a great choice of trigger options
- Dialog for the graphic definition of special functions (determination of the function through a traverse)
- Bus manager for the configuration of data exchange (PROFIBUS DP, PROFINET RT or CANopen) with superior control



The PC program "WIN-PED" is not included in the scope of delivery of the VT-HNC100...3X. Download on the Internet:  
[www.boschrexroth.com/hnc100](http://www.boschrexroth.com/hnc100)

### 7.3 Installation requirements

The following system specifications are required for the PC program WIN-PED®:

- IBM PC or compatible system
- Windows XP or Windows 7 for WIN-PED® 6
- Windows XP or Windows 7 for WIN-PED® 7
- Main memory (recommendation: 512 MB)
- 100 MB available hard drive capacity for each control type
- RS 232 interface for VT-HNC100...3X connection; for the PROFINET RT, EtherNet/IP or PROFIBUS DP, also the network interface TCP/IP can be used
- An interface cable RS232 (length 3 m; Material no. **R900776897**) as well as an USB RS232 converter (Material no. **R901066684**) are **not** included in the scope of delivery, can, however, be ordered separately. See chapter 6.2 "Recommended accessories" on page 21.

### 7.3.1 HNC - PC connection via serial interface

Establish the connection between the VT-HNC100...3X and your PC as follows:

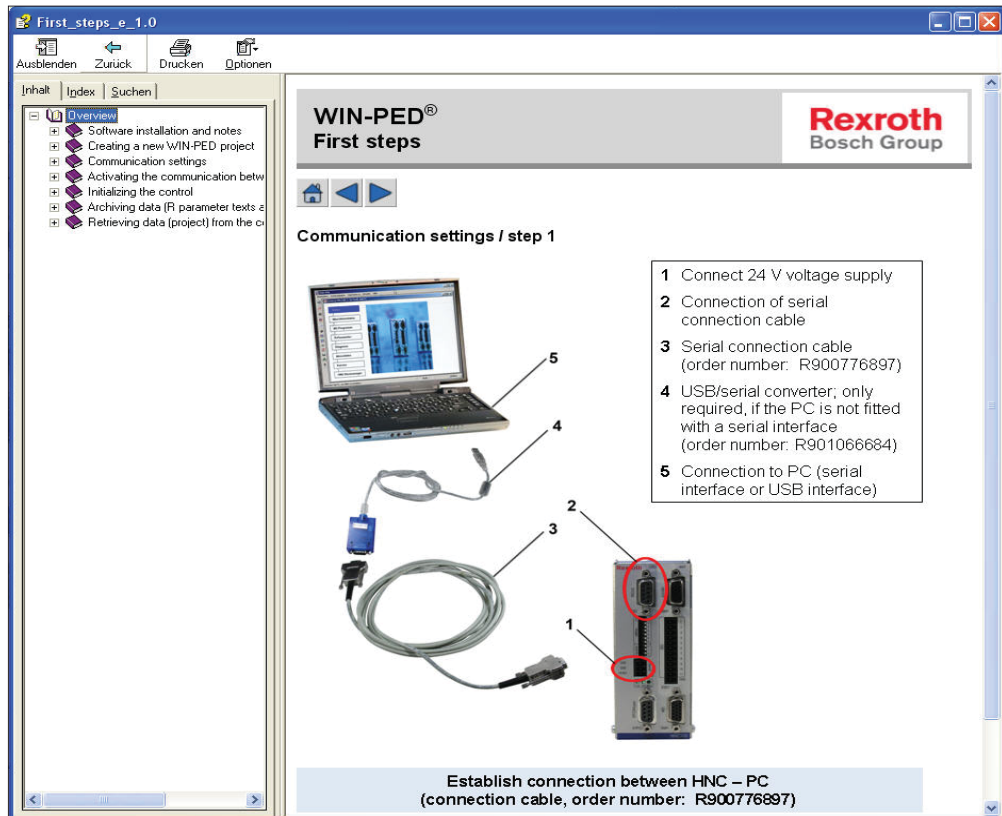

Fig. 20: Connection and required accessories

### 7.3.2 HNC - PC connection via TCP/IP

For Ethernet-capable VT-HNCs, TCP/IP is optionally available as alternative for the serial interface. Please observe the notes in the order code.

#### Make the VT-HNC100...3X ready for operation:

- ▶ Carefully check the wiring.
- ▶ Apply operating voltage to the VT-HNC100...3X.

Please observe the instructions for the installation program when installing WIN-PED®.

- ▶ After having installed the program, you can start it by clicking on it.

Furthermore, the control type applicable for the HNC software must be installed.

## Commissioning

The control types are listed on the download site for WIN-PED®.  
The HNC software must be installed after download:

- ▶ Follow the installation instructions.  
After having installed WIN-PED® and the control types, the WIN-PED® program is ready for operation, and you can start the actual project planning, programming and diagnosis of the control system.

The "First steps" which are available as download under [www.boschrexroth.com/hnc100](http://www.boschrexroth.com/hnc100) will support you when learning how to use the software WIN-PED®.

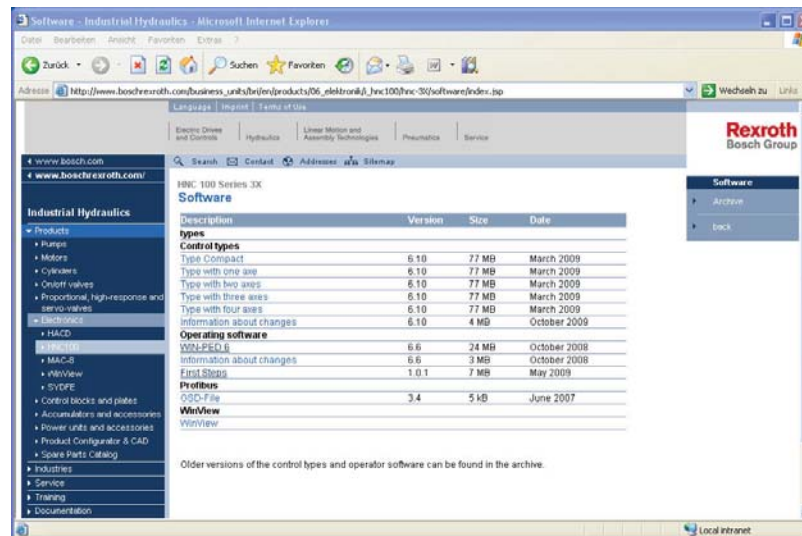

Fig. 21: Download page for WIN-PED® and "First steps"

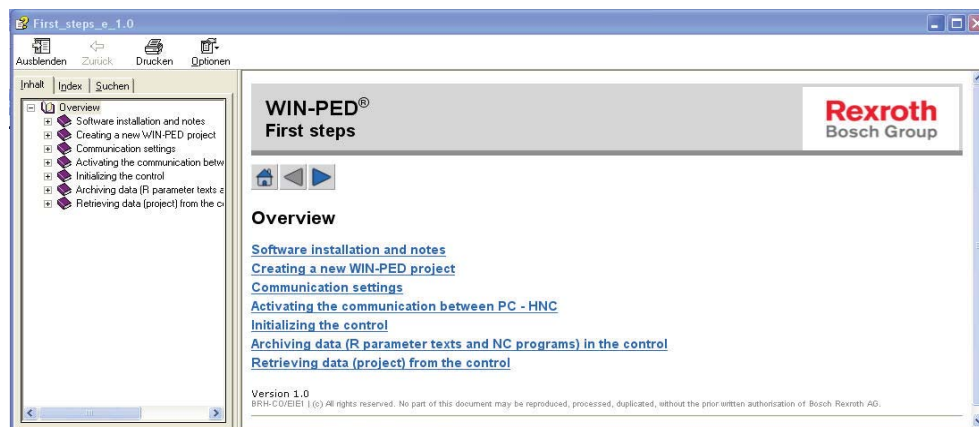

Fig. 22: First steps overview in WIN-PED® 6

The "First steps" will guide you through the whole installation and describe step by step the creation of a new project, communication settings, the activation of

the communication between PC and VT-HNC, the initializing of the control, the archiving of data in the control and the acquisition of data from the control.

- ▶ Creating a new project using the installed HNC software.
- ▶ After having completed project planning and programming, the VT-HNC100...3X must be initialized with this project. Then, the VT-HNC100...3X is ready for operation.

## 8 Operation

During normal operation, the user does not need to intervene.

In case of mains failure during operation, the VT-HNC100...3X can be switched on again without any further measures and is ready for operation.

### 8.1 Software description

The WIN-PED® software is described in the previous chapter 7 "Commissioning".

## 9 Maintenance and repair

### 9.1 Cleaning and care

#### NOTE

##### Failures!

Loss of functionality due to penetrating dirt and humidity!

- ▶ Always provide for absolute cleanness when working on the VT-HNC100...3X.
- ▶ Only use a dry and dust-free cloth for all cleaning works.



Aggressive detergents may damage the VT-HNC100...3X and let it age faster. Never use solvents or aggressive detergents.

For cleaning and maintenance proceed as follows:

- ▶ Perform a visual inspection for checking the tight seat of all lines and screws.
- ▶ Check all plug-in and clamping connections of the VT-HNC100...3X for correct seat and damage at least once per year.
- ▶ Check lines for breakage and squeezing. Have damaged or defective lines exchanged immediately!
- ▶ Clean housing parts with a dry and dust-free cloth.

### 9.2 Maintenance

The maintenance of the VT-HNC100...3X is limited to the cleaning of the surface in order to avoid that dirt and humidity will enter the housing. Regularly check the VT-HNC100...3X for dirt and correct connections taking into account the ambient conditions.

### 9.3 Repair

The VT-HNC100...3X can only be exchanged as whole unit. For safety reasons, modifications at the VT-HNC100...3X performed to one's own authority are not admissible! Repair and maintenance works may only be performed by Bosch Rexroth AG. For repair and maintenance works, send the unit to the service address specified in chapter 15.

Devices returned to Bosch Rexroth for repair must be sent in original packaging.

Repaired devices are returned with default settings.

User-specific settings are not accepted. The user must transfer all appropriate user parameters and programs again.

## 10 Disassembly and replacement

### 10.1 Preparing for disassembly

#### NOTE

**The device might be destroyed!**

- ▶ Decommission the entire system as described in the overall system manual.
- ▶ De-energize the device and all connected components.

### 10.2 Disassembling the digital axis control

Proceed as follows to disassemble the VT-HNC100...3X:

- ▶ Pull off the connection lines and plugs.
- ▶ Release the VT-HNC100...3X from the top hat rail.

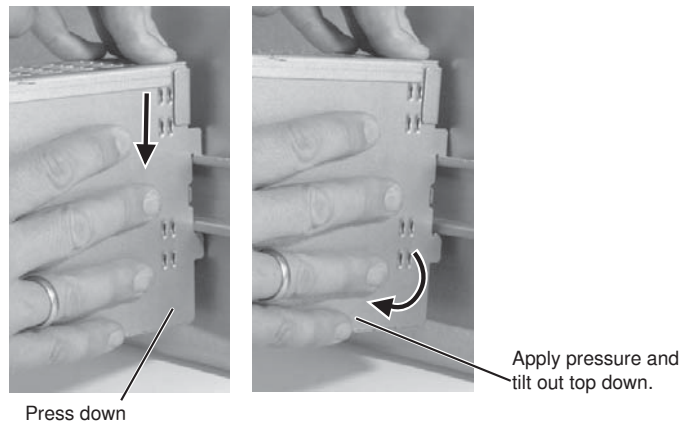

Fig. 23: VT-HNC100...3X disassembly from the top hat rail

### 10.3 Preparing the components for storage/further use

Proceed as follows in order to prepare the VT-HNC100...3X for storage and further use:

- ▶ Only use the genuine packaging for storage.
- ▶ Observe the admissible storage temperature range that is specified in RE 30139.
- ▶ Protect against dust and humidity.

## 11 Disposal

### 11.1 Environmental protection

Careless disposal of the VT-HNC100...3X and the packaging material could lead to pollution of the environment.

- ▶ Thus, dispose of the VT-HNC100...3X and the packaging material in accordance with the currently applicable national regulations in your country.

### 11.2 Return to Bosch Rexroth

The products manufactured by us can be returned to us for disposal purposes at no costs. However, the precondition is that there are no spurious adherences or any other contamination. Furthermore, there must be no inappropriate foreign matter or third party components when products are returned.

The products have to be sent free to the door to the following address:

Bosch Rexroth AG  
Service Industriehydraulik [Industrial hydraulics]  
Bürgermeister-Dr.-Nebel-Straße 8  
97816 Lohr am Main  
Germany

### 11.3 Packagings

Upon request, reusable systems can be used for regular deliveries. The materials for one-way packagings are mostly cardboard, wood, and styrofoam. These can be disposed of without any problems. Due to ecological reasons, one-way packagings should not be used for returning products to us.

### 11.4 Materials used

Our products do not contain any hazardous materials that could be released during intended use. Normally, no adverse effects on human beings and on the environment have to be expected.

The products essentially consist of:

- Electronic components and assemblies

### 11.5 Recycling

Due to the high share of metals the products can mostly be recycled. In order to achieve an ideal metal recovery, disassembly into individual assemblies is required. The metals contained in electric and electronic assemblies can be

recovered by means of special separation procedures as well. If the products contain batteries or accumulators, these have to be removed before recycling and furnished to the battery recycling, if possible.

## 12 Extension and conversion

The VT-HNC100...3X may neither be extended nor converted. If you convert the VT-HNC100...3X, warranty will expire.

## 13 Troubleshooting

### 13.1 How to proceed with troubleshooting

- Always work systematically and focused, even when under time pressure. Random and imprudent disassembly and readjustment of settings might, in the worst-case scenario, result in the inability to restore the original error cause. By readjusting parameters, the drive units operate in an uncontrolled or vibrating manner or do not operate at all due to changed command values, or that they react in any other unexpected way.
- First get a general idea of how your product works in conjunction with the entire system.
- Try to find out whether the product has worked properly in conjunction with the entire system before the error occurred first.
- Try to determine any changes of the entire system in which the product is integrated:
  - Were there changes to the product's operating conditions or operating range?
  - Were there any changes or repair works on the entire system (machine/ system, electrics, control) or on the product?  
If yes: What were they?
  - Was the product or machine used as intended?
  - How did the malfunction become apparent?
  - Try to get a clear idea of the cause of the fault. Directly ask the (machine) operator.
- For troubleshooting, you can use the diagnosis options of WIN-PED® 6 or 7. The diagnosis and failure messages can optionally be read out via field bus.

If you could not remedy the occurred fault, please contact one of the addresses you find at <http://www.boschrexroth.com> or in the address directory in the annex. In case of WIN-PED® software failures, you can visit the website [www.boschrexroth.com/hnc](http://www.boschrexroth.com/hnc). Here, software updates or occurred faults and their remedy are explained.

Technical data

## 14 Technical data

Technical data vary according to the version of the VT-HNC100...3X. A detailed description of you axis control is available in the data sheet RE 30139.

In addition, you can here find data on the two bus systems PROFINET RT and EtherNet/IP:

Bus system	PROFINET RT	EtherNet/IP
Functionality	PROFINET IO RT Device	EtherNet/IP adapter
	Conformance Class A	Remote Reset: 0/1
	Protocols (CM, RTC, RTA, ARP, ICMP, LLDP)	Connection Classes 1/3(Exclusive Owner, Listen Only)
	Alarm support	Unconnected Explicit Messaging
	Max. 1 API supported	DHCP support
Minimum cycle time	2 ms	
Max. size of the cyclic I/O data	992 byte (max. 496 496 byte per direction)	
Transmission rate	100 Mbit/s, full-duplex	
Interface	Integrated cut-through switch – 3-port switch (2 x external, 1 x internal) – Pass-through delay min. 0.9 us / max. 1.4 us	
Specification	Conformity with the relevant IE standard	
Diagnosis LED	2 x port status LEDs (Link, Activity) 1 x module status (red / green) 1 x network status (red / green)	
Recommendations for bus operation	<ul style="list-style-type: none"> <li>– Separation of the IE network from standard Ethernet network (company network)</li> <li>– Alternative connection to the superior standard Ethernet company network via router (e.g. level-3 router)</li> <li>– Separation of standard Ethernet devices (e.g. PCs) in other partial areas (segments) with additional integration into the IE network</li> </ul>	

## 15 Appendix

### 15.1 Address directory

#### 15.1.1 Contact person for repair

Bosch Rexroth AG  
Service Industriehydraulik [Industrial hydraulics]  
Bgm.-Dr. Nebel-Str. 8  
97816 Lohr am Main  
Germany

<http://www.boschrexroth.com/service>  
eMail: [service@boschrexroth.de](mailto:service@boschrexroth.de)

#### 15.1.2 Contact person for support

Bosch Rexroth AG  
Zum Eisengießer 1  
97816 Lohr am Main  
Germany

Phone +49 (93 52) 18-11 32  
Fax +49 (93 52) 18-33 63  
eMail: [support.nc-system@boschrexroth.de](mailto:support.nc-system@boschrexroth.de)

**Rexroth**  
Bosch Group

Subject to change without notice  
Printed in Germany  
RE 30139-B/10.11