

The Drive & Control Company

Rexroth
Bosch Group

Filter elements for installation in
Mahle filter housings

Type 18. filter elements

RE 51466

Edition: 2014-04



- ▶ Frame sizes: 05 to 500
- ▶ Collapse pressure rating: 16 to 210 bar
[232 to 3045 psi]
- ▶ Temperature rating: -30 °C to +100 °C
[-22 to +212 °F]
- ▶ Ratings: 3 µm to 20 µm (DIN 24550 part 2)
- ▶ Filtration ratio: $\beta_{x(c)} > 200$ (ISO 16889)

Features

- ▶ Filter media made of glass fiber material, filter paper, wire mesh, for numerous fields of application
- ▶ Cleanable wire mesh filter media
- ▶ Attainable oil cleanliness up to ISO 12/8/3 (ISO 4406)
- ▶ High dirt holding capacity and filtration performance due to multi-layer glass fiber technology and a low initial pressure differential (ISO 3968)
- ▶ Filter elements with high pressure differential stability

Contents

Features	1
Ordering code	2
Configuration possibilities	3 ... 5
Function, section	5
Filter variables	6
Filter media	7 ... 12
Installation, commissioning, maintenance	13
Directives and standards	13
Exchangeability	13

RE 51466, edition: 2014-04, **Bosch Rexroth AG**

2/14 18. filter elements | RE 51466

Ordering code
Filter element type 18.

01	02	03	04	05	06
18			-	-	0

Filter element

01	Design	18
----	--------	-----------

Size

02	According to Mahle size	1005, 1105, 2105, 5105, 3105, 4105, 8105, 8205, 8305, 8405, 8505, 2205, 5205, 3205, 4205, 9105, 9205, 9305, 9405, 9505	...
		1008, 1108, 2108, 5108, 3108, 4108, 8108, 8208, 8308, 8408, 8508, 2208, 5208, 3208, 4208, 9108, 9208, 9308, 9408, 9508	
		1011, 1111, 2111, 5111, 3111, 4111, 8111, 8211, 8311, 8411, 8511, 2211, 5211, 3211, 4211, 9111, 9211, 9311, 9411, 9511	
		1015, 1115, 2115, 5115, 3115, 4115, 8115, 8215, 8315, 8415, 8515, 2215, 5215, 3215, 4215, 9115, 9215, 9315, 9415, 9515	
		1030, 1130, 2130, 5130, 3130, 4130, 8130, 8230, 8330, 8430, 8530, 2230, 5230, 3230, 4230, 9130, 9230, 9330, 9430, 9530	
		1045, 1145, 2451, 5451, 3451, 4451, 8451, 8245, 8345, 8445, 8545, 2245, 5245, 3245, 4245, 9451, 9245, 9345, 9445, 9545	
		5, 20, 40, 45, 80, 81, 90, 100, 140, 150, 180, 200, 250, 300, 500	

Filter rating in µm

03	Nominal	Stainless steel wire mesh, cleanable	G10 G25 G40 G60 G100
		Filter paper, non-reusable (not cleanable)	P10 P25
	Absolute (ISO 16889)	Glass fiber material, non-reusable (not cleanable)	H3XL H6XL H10XL H20XL

Pressure differential

04	Max. pressure differential of the filter element 160 bar [2321 psi]	C00
	Max. pressure differential of the filter element 16 bar [232 psi]	G00
	Max. pressure differential of the filter element 20 bar [290 psi]	E00
	Max. pressure differential of the filter element 210 bar [3045 psi]	F00

Bypass valve

05	Without bypass valve	0
----	----------------------	---

Seal

06	NBR seal	M
	FKM seal	V

Order example:
18.3105 H10XL-E00-0-M

Material no.: R928018475

More filter ratings, seal materials as well as an HFC/HFA-resistant version are available upon request.

Filter element search with **Fit4Filter** available as Rexroth App (download at the Apple App Store or Google Play Store) **or** as Rexroth online software at www.boschrexroth.de/filter.

Configuration possibilities

Material no.	Designation	Material no.	Designation	Material no.	Designation
R928018471	18.1005 P25-E00-0-M	R928018491	18.1008 P25-E00-0-M	R928018511	18.1011 P25-E00-0-M
R928018472	18.1105 P10-E00-0-M	R928018492	18.1108 P10-E00-0-M	R928018512	18.1111 P10-E00-0-M
R928018473	18.2105 H3XL-E00-0-M	R928018493	18.2108 H3XL-E00-0-M	R928018513	18.2111 H3XL-E00-0-M
R928018474	18.5105 H6XL-E00-0-M	R928018494	18.5108 H6XL-E00-0-M	R928018514	18.5111 H6XL-E00-0-M
R928018475	18.3105 H10XL-E00-0-M	R928018495	18.3108 H10XL-E00-0-M	R928018515	18.3111 H10XL-E00-0-M
R928018476	18.4105 H20XL-E00-0-M	R928018496	18.4108 H20XL-E00-0-M	R928018516	18.4111 H20XL-E00-0-M
R928018477	18.8105 G10-E00-0-M	R928018497	18.8108 G10-E00-0-M	R928018517	18.8111 G10-E00-0-M
R928018478	18.8205 G25-E00-0-M	R928018498	18.8208 G25-E00-0-M	R928018518	18.8211 G25-E00-0-M
R928018479	18.8305 G40-E00-0-M	R928018499	18.8308 G40-E00-0-M	R928018519	18.8311 G40-E00-0-M
R928018480	18.8405 G60-E00-0-M	R928018500	18.8408 G60-E00-0-M	R928018520	18.8411 G60-E00-0-M
R928018481	18.8505 G100-E00-0-M	R928018501	18.8508 G100-E00-0-M	R928018521	18.8511 G100-E00-0-M
R928018482	18.2205 H3XL-F00-0-M	R928018502	18.2208 H3XL-F00-0-M	R928018522	18.2211 H3XL-F00-0-M
R928018483	18.5205 H6XL-F00-0-M	R928018503	18.5208 H6XL-F00-0-M	R928018523	18.5211 H6XL-F00-0-M
R928018484	18.3205 H10XL-F00-0-M	R928018504	18.3208 H10XL-F00-0-M	R928018524	18.3211 H10XL-F00-0-M
R928018485	18.4205 H20XL-F00-0-M	R928018505	18.4208 H20XL-F00-0-M	R928018525	18.4211 H20XL-F00-0-M
R928018486	18.9105 G10-F00-0-M	R928018506	18.9108 G10-F00-0-M	R928018526	18.9111 G10-F00-0-M
R928018487	18.9205 G25-F00-0-M	R928018507	18.9208 G25-F00-0-M	R928018527	18.9211 G25-F00-0-M
R928018488	18.9305 G40-F00-0-M	R928018508	18.9308 G40-F00-0-M	R928018528	18.9311 G40-F00-0-M
R928018489	18.9405 G60-F00-0-M	R928018509	18.9408 G60-F00-0-M	R928018529	18.9411 G60-F00-0-M
R928018490	18.9505 G100-F00-0-M	R928018510	18.9508 G100-F00-0-M	R928018530	18.9511 G100-F00-0-M
R928018531	18.1015 P25-E00-0-M	R928018551	18.1030 P25-E00-0-M	R928018571	18.1045 P25-E00-0-M
R928018532	18.1115 P10-E00-0-M	R928018552	18.1130 P10-E00-0-M	R928018572	18.1145 P10-E00-0-M
R928018533	18.2115 H3XL-E00-0-M	R928018553	18.2130 H3XL-E00-0-M	R928018573	18.2145 H3XL-E00-0-M
R928018534	18.5115 H6XL-E00-0-M	R928018554	18.5130 H6XL-E00-0-M	R928018574	18.5145 H6XL-E00-0-M
R928018535	18.3115 H10XL-E00-0-M	R928018555	18.3130 H10XL-E00-0-M	R928018575	18.3145 H10XL-E00-0-M
R928018536	18.4115 H20XL-E00-0-M	R928018556	18.4130 H20XL-E00-0-M	R928018576	18.4145 H20XL-E00-0-M
R928018537	18.8115 G10-E00-0-M	R928018557	18.8130 G10-E00-0-M	R928018577	18.8145 G10-E00-0-M
R928018538	18.8215 G25-E00-0-M	R928018558	18.8230 G25-E00-0-M	R928018578	18.8245 G25-E00-0-M
R928018539	18.8315 G40-E00-0-M	R928018559	18.8330 G40-E00-0-M	R928018579	18.8345 G40-E00-0-M
R928018540	18.8415 G60-E00-0-M	R928018560	18.8430 G60-E00-0-M	R928018580	18.8445 G60-E00-0-M
R928018541	18.8515 G100-E00-0-M	R928018561	18.8530 G100-E00-0-M	R928018581	18.8545 G100-E00-0-M
R928018542	18.2215 H3XL-F00-0-M	R928018562	18.2230 H3XL-F00-0-M	R928018582	18.2245 H3XL-F00-0-M
R928018543	18.5215 H6XL-F00-0-M	R928018563	18.5230 H6XL-F00-0-M	R928018583	18.5245 H6XL-F00-0-M
R928018544	18.3215 H10XL-F00-0-M	R928018564	18.3230 H10XL-F00-0-M	R928018584	18.3245 H10XL-F00-0-M
R928018545	18.4215 H20XL-F00-0-M	R928018565	18.4230 H20XL-F00-0-M	R928018585	18.4245 H20XL-F00-0-M
R928018546	18.9115 G10-F00-0-M	R928018566	18.9130 G10-F00-0-M	R928018586	18.9145 G10-F00-0-M
R928018547	18.9215 G25-F00-0-M	R928018567	18.9230 G25-F00-0-M	R928018587	18.9245 G25-F00-0-M
R928018548	18.9315 G40-F00-0-M	R928018568	18.9330 G40-F00-0-M	R928018588	18.9345 G40-F00-0-M
R928018549	18.9415 G60-F00-0-M	R928018569	18.9430 G60-F00-0-M	R928018589	18.9445 G60-F00-0-M
R928018550	18.9515 G100-F00-0-M	R928018570	18.9530 G100-F00-0-M	R928018590	18.9545 G100-F00-0-M

4/14 18. filter elements | RE 51466

Configuration possibilities

Material no.	Designation	Material no.	Designation	Material no.	Designation
R928018591	18.5 H3XL-G00-0-M	R928018611	18.20 H3XL-G00-0-M	R928018631	18.40 H3XL-G00-0-M
R928018592	18.5 H10XL-G00-0-M	R928018612	18.20 H10XL-G00-0-M	R928018632	18.40 H10XL-G00-0-M
R928018593	18.5 H20XL-G00-0-M	R928018613	18.20 H20XL-G00-0-M	R928018633	18.40 H20XL-G00-0-M
R928018594	18.5 H3XL-C00-0-M	R928018614	18.20 H3XL-C00-0-M	R928018634	18.40 P10-G00-0-M
R928018595	18.5 H10XL-C00-0-M	R928018615	18.20 H10XL-C00-0-M	R928018635	18.40 P25-G00-0-M
R928018596	18.5 H20XL-C00-0-M	R928018616	18.20 H20XL-C00-0-M	R928018636	18.40 G10-G00-0-M
R928018597	18.5 P10-G00-0-M	R928018617	18.20 P10-G00-0-M	R928018637	18.40 G25-G00-0-M
R928018598	18.5 P25-G00-0-M	R928018618	18.20 P25-G00-0-M	R928018638	18.40 G40-G00-0-M
R928018599	18.5 P10-C00-0-M	R928018619	18.20 P10-C00-0-M	R928018639	18.40 G60-G00-0-M
R928018600	18.5 P25-C00-0-M	R928018620	18.20 P25-C00-0-M	R928018640	18.40 G100-G00-0-M
R928018601	18.5 G10-G00-0-M	R928018621	18.20 G10-G00-0-M	R928018641	18.40 H3XL-C00-0-M
R928018602	18.5 G25-G00-0-M	R928018622	18.20 G25-G00-0-M	R928018642	18.40 H10XL-C00-0-M
R928018603	18.5 G40-G00-0-M	R928018623	18.20 G40-G00-0-M	R928018643	18.40 H20XL-C00-0-M
R928018604	18.5 G60-G00-0-M	R928018624	18.20 G60-G00-0-M	R928018644	18.40 P10-C00-0-M
R928018605	18.5 G100-G00-0-M	R928018625	18.20 G100-G00-0-M	R928018645	18.40 P25-C00-0-M
R928018606	18.5 G10-C00-0-M	R928018626	18.20 G10-C00-0-M	R928018646	18.40 G10-C00-0-M
R928018607	18.5 G25-C00-0-M	R928018627	18.20 G25-C00-0-M	R928018647	18.40 G25-C00-0-M
R928018608	18.5 G40-C00-0-M	R928018628	18.20 G40-C00-0-M	R928018648	18.40 G40-C00-0-M
R928018609	18.5 G60-C00-0-M	R928018629	18.20 G60-C00-0-M	R928018649	18.40 G60-C00-0-M
R928018610	18.5 G100-C00-0-M	R928018630	18.20 G100-C00-0-M	R928018650	18.40 G100-C00-0-M
R928018651	18.45 H10XL-G00-0-M	R928018677	18.81 P10-G00-0-M	R928018693	18.100 H3XL-G00-0-M
R928018652	18.45 H20XL-G00-0-M	R928018678	18.81 P25-G00-0-M	R928018694	18.100 H10XL-G00-0-M
R928018653	18.45 P10-G00-0-M	R928018679	18.81 H6XL-G00-0-M	R928018695	18.100 H20XL-G00-0-M
R928018654	18.45 P25-G00-0-M	R928018680	18.81 H10XL-G00-0-M	R928018696	18.100 H3XL-C00-0-M
R928018655	18.45 G25-G00-0-M	R928018681	18.81 H20XL-G00-0-M	R928018697	18.100 H10XL-C00-0-M
R928018656	18.45 G40-G00-0-M	R928018682	18.81 G25-G00-0-M	R928018698	18.100 H20XL-C00-0-M
R928018657	18.80 H3XL-G00-0-M	R928018683	18.81 G40-G00-0-M	R928018699	18.100 P10-G00-0-M
R928018658	18.80 H10XL-G00-0-M	R928018684	18.90 H3XL-G00-0-M	R928018700	18.100 P25-G00-0-M
R928018659	18.80 H20XL-G00-0-M	R928018685	18.90 H10XL-G00-0-M	R928018701	18.100 P10-C00-0-M
R928018660	18.80 P10-G00-0-M	R928018686	18.90 H20XL-G00-0-M	R928018702	18.100 P25-C00-0-M
R928018661	18.80 P25-G00-0-M	R928018687	18.90 P10-G00-0-M	R928018703	18.100 G10-G00-0-M
R928018662	18.80 G10-G00-0-M	R928018688	18.90 P25-G00-0-M	R928018704	18.100 G25-G00-0-M
R928018663	18.80 G25-G00-0-M	R928018689	18.90 G10-G00-0-M	R928018705	18.100 G60-G00-0-M
R928018664	18.80 G40-G00-0-M	R928018690	18.90 G25-G00-0-M	R928018706	18.100 G100-G00-0-M
R928018665	18.80 G60-G00-0-M	R928018691	18.90 G60-G00-0-M	R928018707	18.100 G10-C00-0-M
R928018666	18.80 G100-G00-0-M	R928018692	18.90 G100-G00-0-M	R928018708	18.100 G25-C00-0-M
R928018667	18.80 H3XL-C00-0-M			R928018709	18.100 G60-C00-0-M
R928018668	18.80 H10XL-C00-0-M			R928018710	18.100 G100-C00-0-M
R928018669	18.80 H20XL-C00-0-M				
R928018670	18.80 P10-C00-0-M				
R928018671	18.80 P25-C00-0-M				
R928018672	18.80 G10-C00-0-M				
R928018673	18.80 G25-C00-0-M				
R928018674	18.80 G40-C00-0-M				
R928018675	18.80 G60-C00-0-M				
R928018676	18.80 G100-C00-0-M				

Bosch Rexroth AG, RE 51466, edition: 2014-04

Configuration possibilities

Material no.	Designation	Material no.	Designation	Material no.	Designation
R928018711	18.140 H3XL-G00-0-M	R928018729	18.150 P5-G00-0-M	R928018752	18.250 P10-G00-0-M
R928018712	18.140 H10XL-G00-0-M	R928018730	18.150 P10-G00-0-M	R928018753	18.250 P25-G00-0-M
R928018713	18.140 H20XL-G00-0-M	R928018731	18.150 P25-G00-0-M	R928018754	18.250 H3XL-G00-0-M
R928018714	18.140 H3XL-C00-0-M	R928018732	18.150 H3XL-G00-0-M	R928018755	18.250 H6XL-G00-0-M
R928018715	18.140 H10XL-C00-0-M	R928018733	18.150 H10XL-G00-0-M	R928018756	18.250 H10XL-G00-0-M
R928018716	18.140 H20XL-C00-0-M	R928018734	18.150 H20XL-G00-0-M	R928018757	18.250 H20XL-G00-0-M
R928018717	18.140 P10-G00-0-M	R928018735	18.180 P10-G00-0-M	R928018758	18.250 G25-G00-0-M
R928018718	18.140 P25-G00-0-M	R928018736	18.180 P25-G00-0-M	R928018759	18.250 G40-G00-0-M
R928018719	18.140 P10-C00-0-M	R928018737	18.180 H3XL-G00-0-M	R928018760	18.300 P10-G00-0-M
R928018720	18.140 P25-C00-0-M	R928018738	18.180 H6XL-G00-0-M	R928018761	18.300 P25-G00-0-M
R928018721	18.140 G10-G00-0-M	R928018739	18.180 H10XL-G00-0-M	R928018762	18.300 H10XL-G00-0-M
R928018722	18.140 G25-G00-0-M	R928018740	18.180 H20XL-G00-0-M	R928018763	18.300 H20XL-G00-0-M
R928018723	18.140 G60-G00-0-M	R928018741	18.180 G25-G00-0-M	R928018764	18.300 G10-G00-0-M
R928018724	18.140 G100-G00-0-M	R928018742	18.180 G40-G00-0-M	R928018765	18.300 G25-G00-0-M
R928018725	18.140 G10-C00-0-M	R928018743	18.200 H3XL-G00-0-M	R928018766	18.300 G60-G00-0-M
R928018726	18.140 G25-C00-0-M	R928018744	18.200 H10XL-G00-0-M	R928018767	18.300 G100-G00-0-M
R928018727	18.140 G60-C00-0-M	R928018745	18.200 H20XL-G00-0-M	R928018768	18.500 P10-G00-0-M
R928018728	18.140 G100-C00-0-M	R928018746	18.200 P10-G00-0-M	R928018769	18.500 P25-G00-0-M
		R928018747	18.200 P25-G00-0-M	R928018770	18.500 H10XL-G00-0-M
		R928018748	18.200 G10-G00-0-M	R928018771	18.500 H20XL-G00-0-M
		R928018749	18.200 G25-G00-0-M	R928018772	18.500 G10-G00-0-M
		R928018750	18.200 G60-G00-0-M	R928018773	18.500 G25-G00-0-M
		R928018751	18.200 G100-G00-0-M	R928018774	18.500 G60-G00-0-M
				R928018775	18.500 G100-G00-0-M

Function, section

The filter element is the central component of industrial filters. The actual filtration process takes place in the filter element. The applied filter elements and the filter media used in the filter elements determine the major filter variables such as size range of particle retention, dirt holding capacity and pressure loss. Rexroth filter elements are used for the filtration of hydraulic fluids in the hydraulic system as well as for the filtration of lubricants, industrial fluids and gases.

Filter elements consist of a combination of radially pleated filter media (3) which are laid around a perforated support tube (2). Support tube and filter element mat are glued to both end caps (1). Seals are provided between the filter element and the filter housing as a seal.

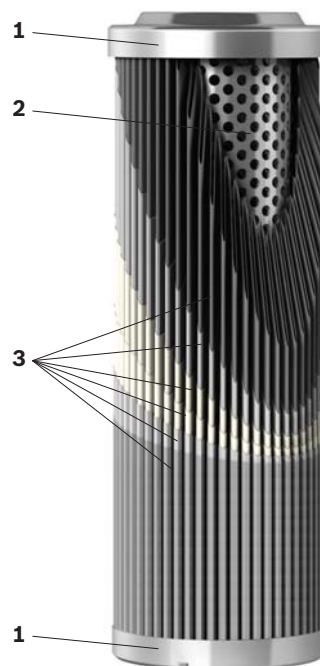

RE 51466, edition: 2014-04, Bosch Rexroth AG

6/14 18. filter elements | RE 51466

Filter variables

Filter rating and attainable oil cleanliness

The main goal when using industrial filters is not only the direct protection of machine components but to attain the target oil cleanliness. Oil cleanliness is defined on the

basis of oil cleanliness classes which classify how the amount of particles of the existing contamination is distributed in the operating liquid.

Filtration performance

Filtration ratio $\beta_{x(c)}$ (β value)

The retention capacity of hydraulic filters in a hydraulic system is defined by the filtration ratio $\beta_{x(c)}$. This variable is therefore the most important performance characteristic of a hydraulic filter. It is measured in the multipass test, and is the average value of the specified initial and final pressure differential according to ISO 16889 using ISOMTD test dust.

The filtration ratio $\beta_{x(c)}$ is defined as the ratio of the particle count of the respective particle size on both sides of the filter.

Dirt holding capacity

It is also measured using the multipass test and determines the amount of test dust ISOMTD which is fed to the filter media until a specified pressure differential increase has been reached.

Pressure loss (also pressure differential or delta p)

The pressure loss of the filter element is the relevant characteristic value for the determination of the filter size. The pressure loss with a clean filter element is recommended by the filter manufacturer or defined by the system manufacturer.

This characteristic value depends on many factors. Mainly: The rating of the filter media, its geometry and arrangement in the filter element, the filter area, the operating viscosity of the fluid and the flow.

The term "delta p" is often also expressed with the symbol " Δp ".

When dimensioning the filter, an initial pressure loss is determined which must not be exceeded by the new filter element based on the aforementioned conditions.

The following diagram shows the typical pressure loss behavior of filter elements with different filter media at different flows for a viscosity of 30 mm²/s [150 SUS].

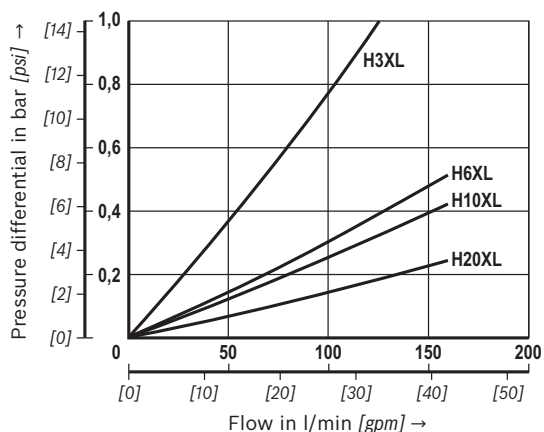
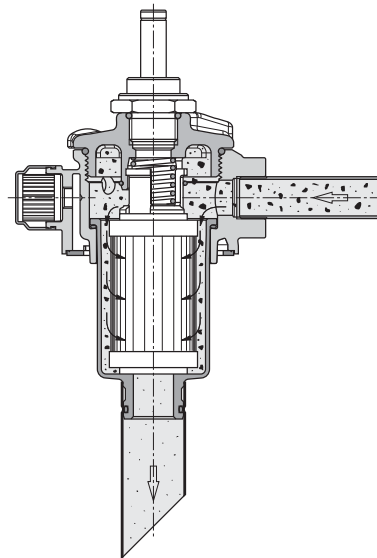

Bosch Rexroth AG, RE 51466, edition: 2014-04

Filter media

Overview

Depending on the application and requirements, different filter media in different filtration ratings are used for the separation of particles.

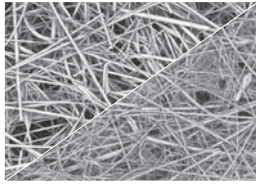
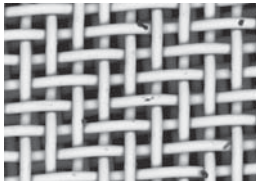
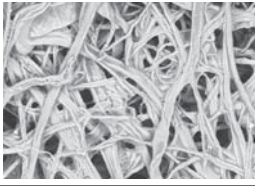
Filter media/set-up	Electron microscope image
<p>H...XL, glass fiber material Depth filter, combination of inorganic micro glass filter media. High dirt holding capacity due to multi-layer technology.</p>	
<p>G..., stainless steel wire mesh material 1.4401 or 1.4571 Surface filter made of stainless steel wire mesh with supporting layer.</p>	
<p>P..., filter paper Inexpensive depth filter made of filter paper with supporting layer. Made of specially coated cellulose fiber preventing humidity and swelling.</p>	

8/14 **18. filter elements** | RE 51466

Technical data

(For applications outside these parameters, please consult us!)

general		
Filtration direction		From the outside to the inside
Ambient temperature range	°C [°F]	-30 ... +65 [-22... +149]
Material	- Cover/base	Steel, aluminum or plastic (depending on the version)
	- Support tube	Steel
	- Seals	NBR or FKM
hydraulic		
Hydraulic fluid temperature range	°C [°F]	-20 ... +100 [-4... +212]
Minimum conductivity of the media	pS/m	300

Compatibility with permitted hydraulic fluids

Hydraulic fluid	Classification	Suitable sealing materials	Standards
Mineral oil	HLP	NBR	DIN 51524



Important information on hydraulic fluids!

► For more information and data on the use of other hydraulic fluids, please refer to data sheet 90220 or contact us!

► HFC/HFA and other hydraulic special fluids upon request.

Filter media

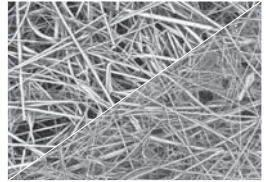
Technical data	H...XL
<p>Glass fiber material, H...XL</p> <p>This filter media achieves the best possible cleanliness level when compared to other filter media. It is suitable for fluids such as hydraulic oils, lubricants, chemical and industrial liquids. Due to its defined dirt holding capacity (ISO 16889), it offers highly effective protection for machines and system components which are sensitive to contamination.</p> <ul style="list-style-type: none"> - H...XL depth filter made of inorganic glass fiber material - Absolute filtration/defined retention capacity according to ISO 16889 - High dirt holding capacity due to multi-layer set-up - Non-reusable filter (not cleanable due to the depth filter effect) - Attainable oil cleanliness classes according to ISO 4406 up to ISO code 13/10/8 and better 	
<p>Filter rating and attainable oil cleanliness</p> <p>The following table provides recommendations for the selection of a filter media in dependency of the application and indicates the average oil cleanliness class attainable according to ISO 4406 or SAE-AS 4059.</p>	

Glass fiber material

Contamination class DIN ISO 4406	To be achieved with filter			Hydraulic system
	$\beta_{x(c)} = 200$	Material	Arrangement	
13/10/8 ... 17/13/10	3 μm	Glass fiber material H...XL	Pressure filter	Servo valves
15/12/10 ... 19/14/11	6 μm			High-response valves
17/14/10 ... 21/16/13	10 μm		Return flow or pressure filters	Proportional valves
19/16/12 ... 22/17/14	20 μm			Pumps and valves in general

Attainable filtration ratio $\beta_{x(c)}$ (β value)

Typical β values of up to 2.2 bar [31.9 psi] Δp pressure increase at the filter element ¹⁾

Filter media	Particle size "x" for different β values, measurement according to ISO 16889		
	$\beta_{x(c)} \geq 75$	$\beta_{x(c)} \geq 200$	$\beta_{x(c)} \geq 1000$
H3XL	4.0 $\mu\text{m}(c)$	< 4.5 $\mu\text{m}(c)$	5.0 $\mu\text{m}(c)$
H6XL	4.8 $\mu\text{m}(c)$	5.5 $\mu\text{m}(c)$	7.5 $\mu\text{m}(c)$
H10XL	6.5 $\mu\text{m}(c)$	7.5 $\mu\text{m}(c)$	9.5 $\mu\text{m}(c)$
H20XL	18.5 $\mu\text{m}(c)$	20.0 $\mu\text{m}(c)$	22.0 $\mu\text{m}(c)$

¹⁾ Filtration ratio $\beta_{x(c)}$ for other filter media upon request

Filtration ratio $\beta_{x(c)}$ as a function of particle size $\mu\text{m}(c)$

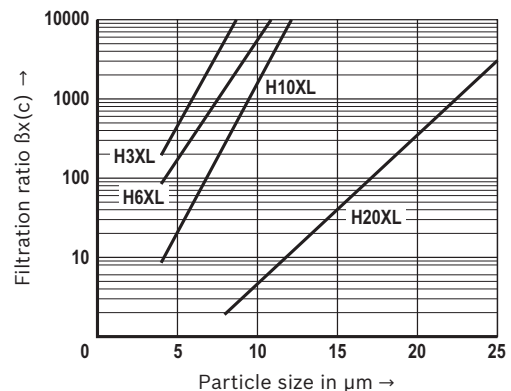

10/14 18. filter elements | RE 51466

Filter media

Technical data

H...XL

Dirt holding capacity

Compared to conventional filter media with single layer technology, the H...XL filter material features a high dirt holding capacity because it is made of two separate filter layers connected in series.

Conventional filter element - - - -
(single-layer glass fiber material)
Rexroth H...XL filter element ————
(multi-layer glass fiber material)

Superior dirt holding capacity of H...XL filter elements

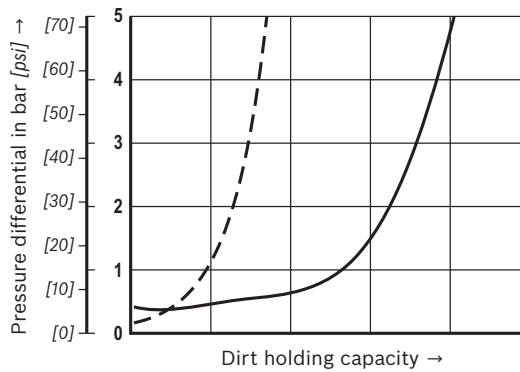

Technical data

G...

Stainless steel wire mesh, G...

There is a comprehensive field of applications for wire mesh filter media. Not only pre-filtration is possible, but also the filtration of lubricating oils, hydraulic oils, coolants and water-like fluids.

- Surface filter made of stainless steel wire mesh
- Reusable, cleanable
- Pleated design, single-, two- or three-layer design

Wire mesh G10 ... G40

As surface filters, these materials are generally cleanable. Due to their fine mesh, however, cleaning is more difficult than with coarser filter mesh. Therefore, we recommend cleaning the filters in an ultrasonic bath.

Wire mesh G60 ... G100

Due to their coarser mesh size, the cleaning of these filter media is easier.

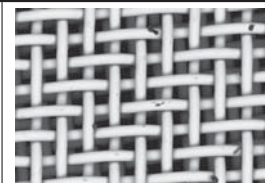

Filter media	Design	Mesh size
G10	Special Dutch weave	10 µm nom.
G25	Woven mesh	25 µm nom.
G40	Woven mesh	40 µm nom.
G60 ... G100	Plain cloth	60 ... 100 µm nom.

Bosch Rexroth AG, RE 51466, edition: 2014-04

Filter media

Technical data	G...
----------------	------

Stainless steel wire mesh

Contamination class DIN ISO 4406	To be achieved with filter			Fluid system
	Nominal	Material	Arrangement	
20/18/13 ... 21/20/15	10 µm	Stainless steel wire mesh, G...	Pressure filter	For existing systems (hydraulics) and as protective filter (G10, G25) For fluids such as: – Lubricants – Petrochemical products – Water – Coolants/thermal oils
Cannot be used for wire mesh > 10 µm	25 ... 100 µm		Return flow, pressure filters or suction filters	

Cleaning of filter elements

Cleaning or replacement

Before cleaning a filter element made of wire mesh, it has to be checked after dismantling of the filter element whether it makes sense to clean the element. For example, if the cloth contains many fibrous substances and consists of a material finer than G40, effective and complete cleaning is not possible in many cases. Filter mesh which has visible defects due to frequent cleaning must be replaced. In general, the following applies: The finer the cloth, the thinner the wire. Therefore, especially fine mesh must be cleaned gently to protect the material. The wire mesh must not show any cracks in the folds as otherwise, the filter capacity will be insufficient.

Cleaning frequency

Experience has shown that filter elements made of G10, G25 and G40 can be cleaned up to ten times. Filter mesh > 60 µm can usually be cleaned more than ten times. Reusability, however, very much depends on the type of contamination as well as on the pressure differential during operation (final Δp before dismantling the filter element). For maximum reusability, we therefore recommend replacing in particular the fine mesh at a final Δp of 2.2 bar [31,9 psi] at the latest. Due to the given reasons, the aforementioned values must be regarded as reference values for which we do not assume any liability.

Recommendations for cleaning

Manual and simple cleaning method for filter elements made of wire mesh

Procedure	Wire mesh G10, G25, G40	Wire mesh G60 ... G100
Chemical pre-cleaning	Let the filter element drain for approx. 1 hour after disassembly. Bathe in solvent afterwards.	
Mechanical pre-cleaning	Remove rough dirt with a brush or scrubber. Do not use hard or pointed objects which could damage the filter media.	
Mechanical/chemical main cleaning	Put pre-cleaned element in an ultrasonic bath with special solvent. Clean the element in the ultrasonic bath until all visible contamination is removed.	Evaporate with hot washing solution (water with corrosion protection agent)
Test	Visually check the material for damage. Replace the filter element if you identify obvious damage.	
Preservation	After drying, you must spray the cleaned element with preservative agents and store it sealed against dust in a plastic foil.	

12/14 18. filter elements | RE 51466

Filter media

Technical data G...

Automated cleaning for filter elements made of wire mesh

Procedure	Wire mesh G10, G25, G40, G60 ... G100
Chemical pre-cleaning	Let the filter element drain for approx. 1 hour after disassembly. Bathe in solvent afterwards.
Mechanical/chemical main cleaning	By means of special cleaning systems for filter elements. Most of these systems are provided with a fully automated and combined cleaning mechanism including ultrasound as well as mechanical and chemical cleaning processes. This allows for best possible cleaning results with gentle cleaning processes.

Technical data P...

Filter paper, P...

Filter paper is used for the filtration of lubricating oil and for pre-filtration.
Filter paper has the following features:

- Depth filter made of cellulose fibers
- Specially coated to prevent swelling caused by humidity
- Pleated design, single-, two- or three-layer design
- Non-reusable filter (not cleanable due to the depth filter effect)

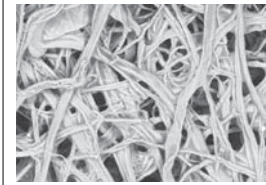

Filter media	Filtration ratio β values ¹⁾	Retention rate ¹⁾
P10	$\beta_{10(c)} > 2.0$	50 %
P25	$\beta_{10(c)} > 1.25$	20 %

¹⁾ According to ISO 16889

Filter paper

Contamination class DIN ISO 4406	To be achieved with filter			Hydraulic system
	$\beta_{x(c)} = 200$	Material	Arrangement	
20/19/14 ... 22/20/15	10 μ m	Paper P...	Return flow or pressure filters	For existing systems
21/20/15 ... 22/21/16	25 μ m			

Bosch Rexroth AG, RE 51466, edition: 2014-04

Installation, commissioning, maintenance

When does the filter element have to be replaced or cleaned?

As soon as the dynamic pressure or the pressure differential set at the maintenance indicator is reached, the red button of the optical, mechanical maintenance indicator pops out. If an electronic switching element is provided, an electric signal output is also provided. In this case, the filter element must be replaced or cleaned. Filter elements should be replaced or cleaned after max. 6 months.

Notice:

If the maintenance indicator signal is ignored, the increasing pressure differential may damage the filter element causing it to collapse.

Filter element exchange

Detailed instructions with regard to the exchange of filter elements can be found in the data sheet of the relevant filter series.

WARNING!

Filters are containers under pressure. Before opening the filter housing, check whether the system pressure in the filter has been decreased to ambient pressure. Only then may the filter housing be opened for maintenance. Warranty becomes void if the delivered item is changed by the ordering party or third parties or improperly mounted, installed, maintained, repaired, used or exposed to environmental conditions that do not comply with the installation conditions.

Directives and standards

Rexroth filter elements are tested and quality-monitored according to different ISO test standards:

Filtration performance test (multipass test)	ISO 16889:2008-06
Δp (pressure loss) characteristic curves	ISO 3968:2001-12
Compatibility with hydraulic fluid	ISO 2943:1998-11
Collapse pressure test	ISO 2941:2009-04

The development, manufacture and assembly of Rexroth industrial filters and Rexroth filter elements is carried out within the framework of a certified quality management system in accordance with ISO 9001:2000.

Exchangeability

Rexroth filter elements for installation in Mahle filter housings are exchangeable with regard to their dimensions with the aforementioned competitive filter elements.

They comply with the state-of-the-art in technology and are developed and tested according to specific test procedures such as ISO 16889 (filtration performance test), ISO 2941

(collapse pressure) and ISO 3968 (pressure loss).

The Rexroth filter elements recommended by us are exclusively intended for intended applications. They must be maintained regularly and replaced, if necessary.